

Cold-formed Steel Truss Tutorial

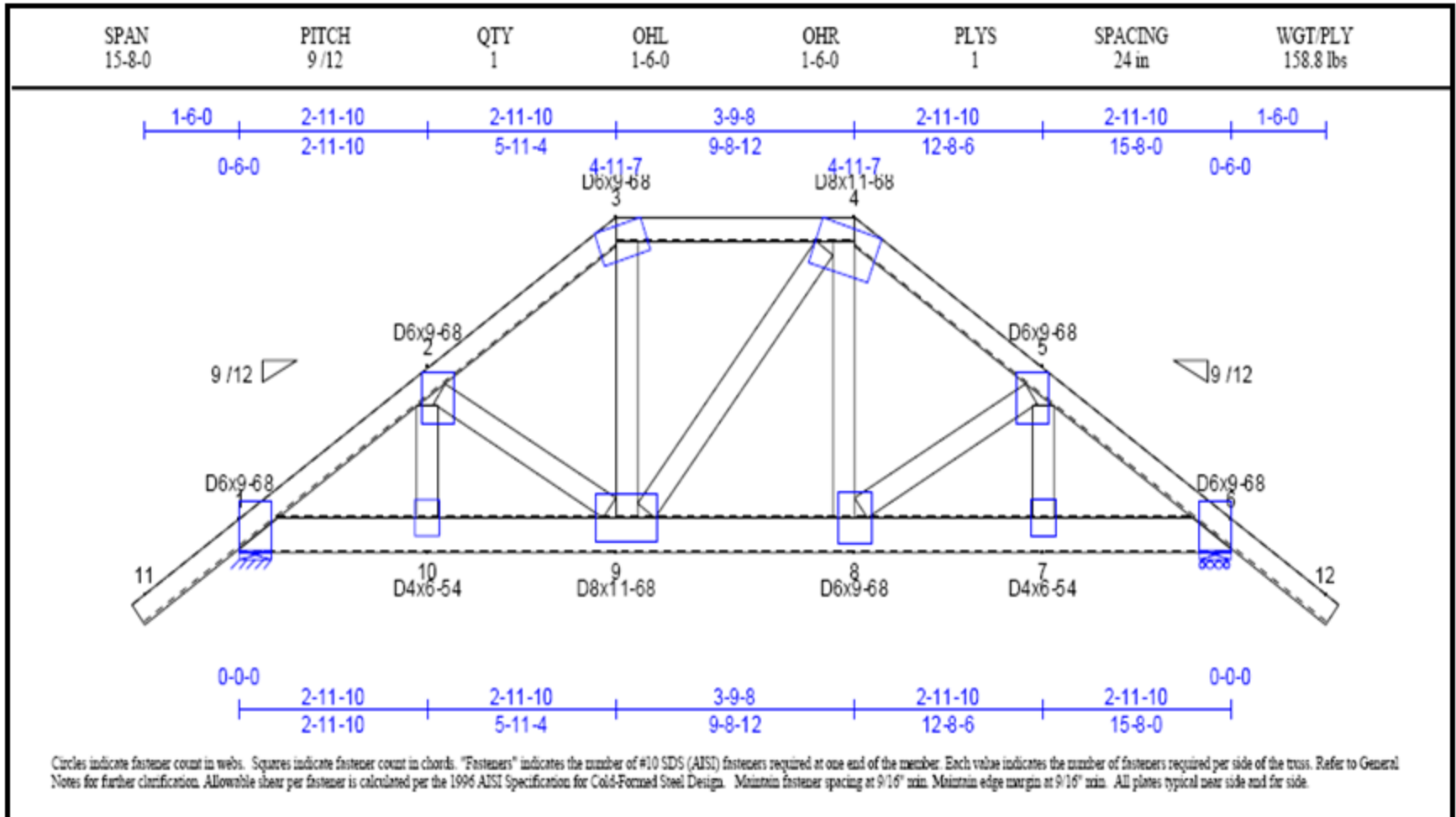

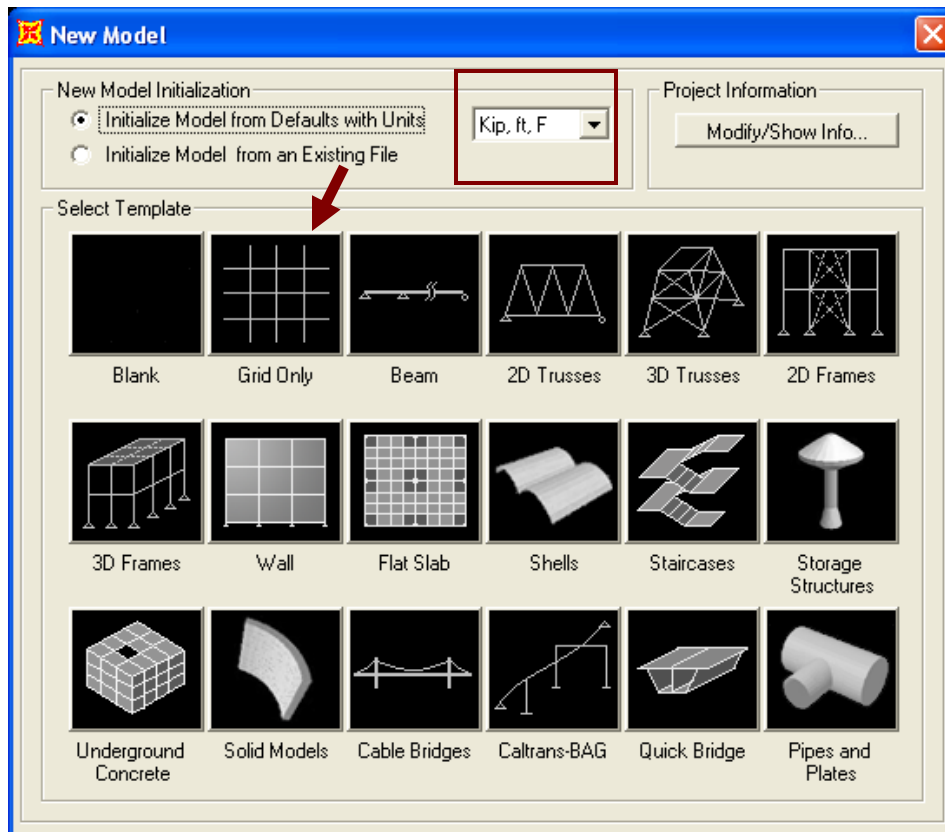

Click File>New. Although SAP2000 offers several templates, it's often necessary to use grids in order to create a custom structure. From the main menu, select units to be Kip, ft, F and click 'Grid only'. Based on the G26_15 drawing, we see that the bottom chord is 15'8" long, and because the height of the truss was not provided, we must calculate the height of the truss using other available dimensions. Take the bottom cord dimension of 5'11" 4/16 (5.9375') and multiply by .75, which corresponds to 9/12 pitch in order to determine truss height of 4.453' (5.8375' X .75). Since the truss will be modeled in XZ plane (2D only), we'll start by defining perimeter grids which we will refine later. Grid lines and spacing should be input as shown below right, with 1 in the Y direction so as not to display it. Note in the Grid spacing X direction below, that SAP2000 enables you to input using architectural units, 15'8" in this example, and after you tab from that field it will automatically convert to feet decimal. SAP2000 does not allow for additional fractional inch units such as 2'11" 10/16. Press OK to accept gridlines.

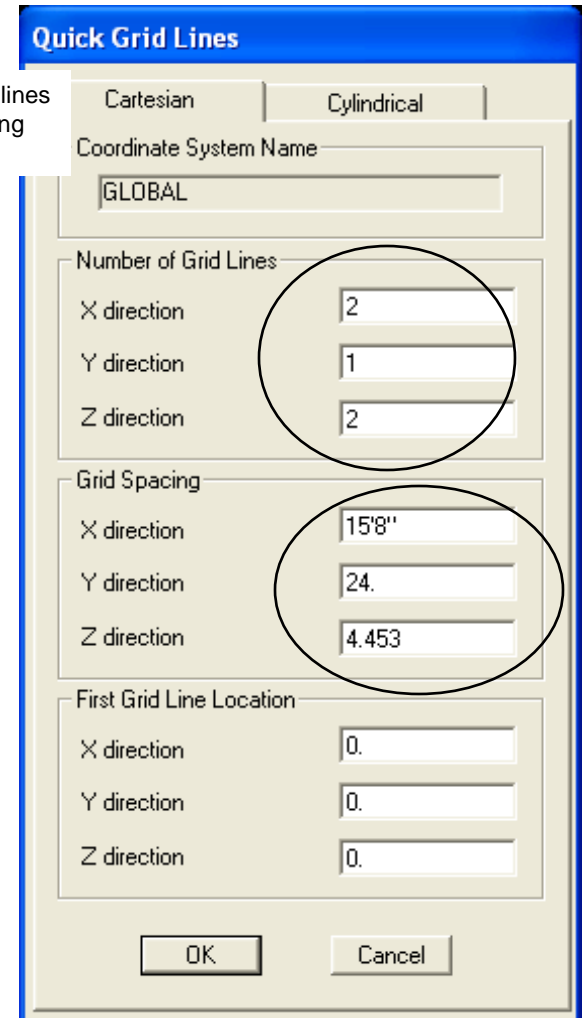

Type grid lines and spacing as shown



Click once in the left window to make it the 'active' window, then click the xz button  which switches the planar view as shown below right. Note the up/down arrows  . If there were additional grids in the Y direction which there are not, for future reference you can use these arrows to scroll through the model in any planar view. Units are located in the bottom right portion of the main SAP2000 screen and can be changed anytime.

Click xz button

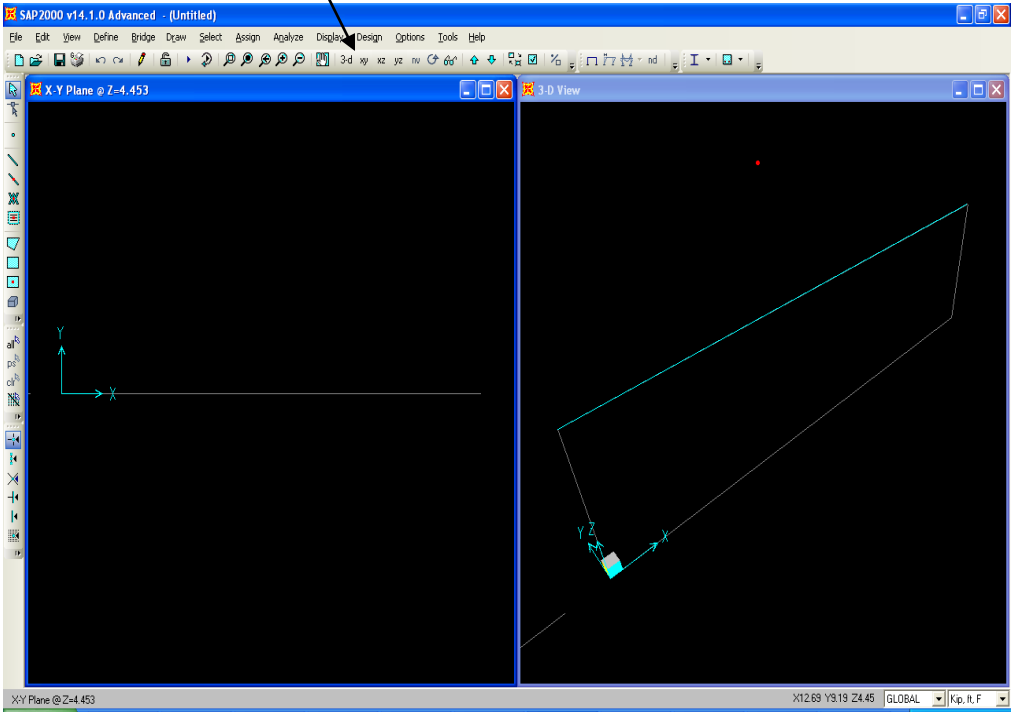

XZ planar view

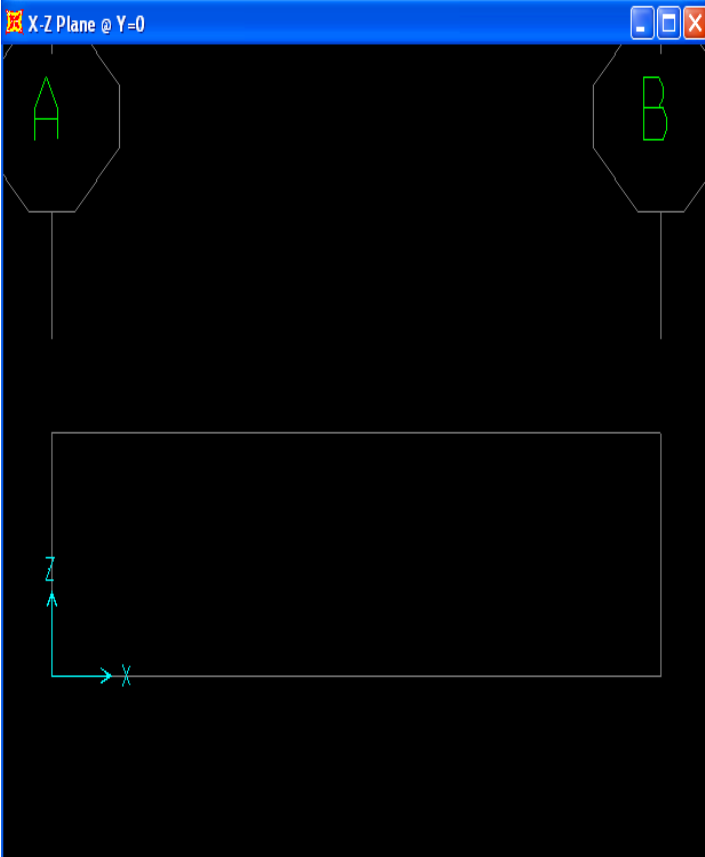

Units

Click 'Draw special joint' button  , type 2.9687 in offset X, then click the bottom left corner (which happens to be the origin) to draw the joint. If the 'Draw special joint' button does not appear on your palette, add it using the 'more buttons' icon or access it under the Draw menu. We will generate our truss geometry by adding joints to supplement our grids, then we will connect the dots to create our truss.

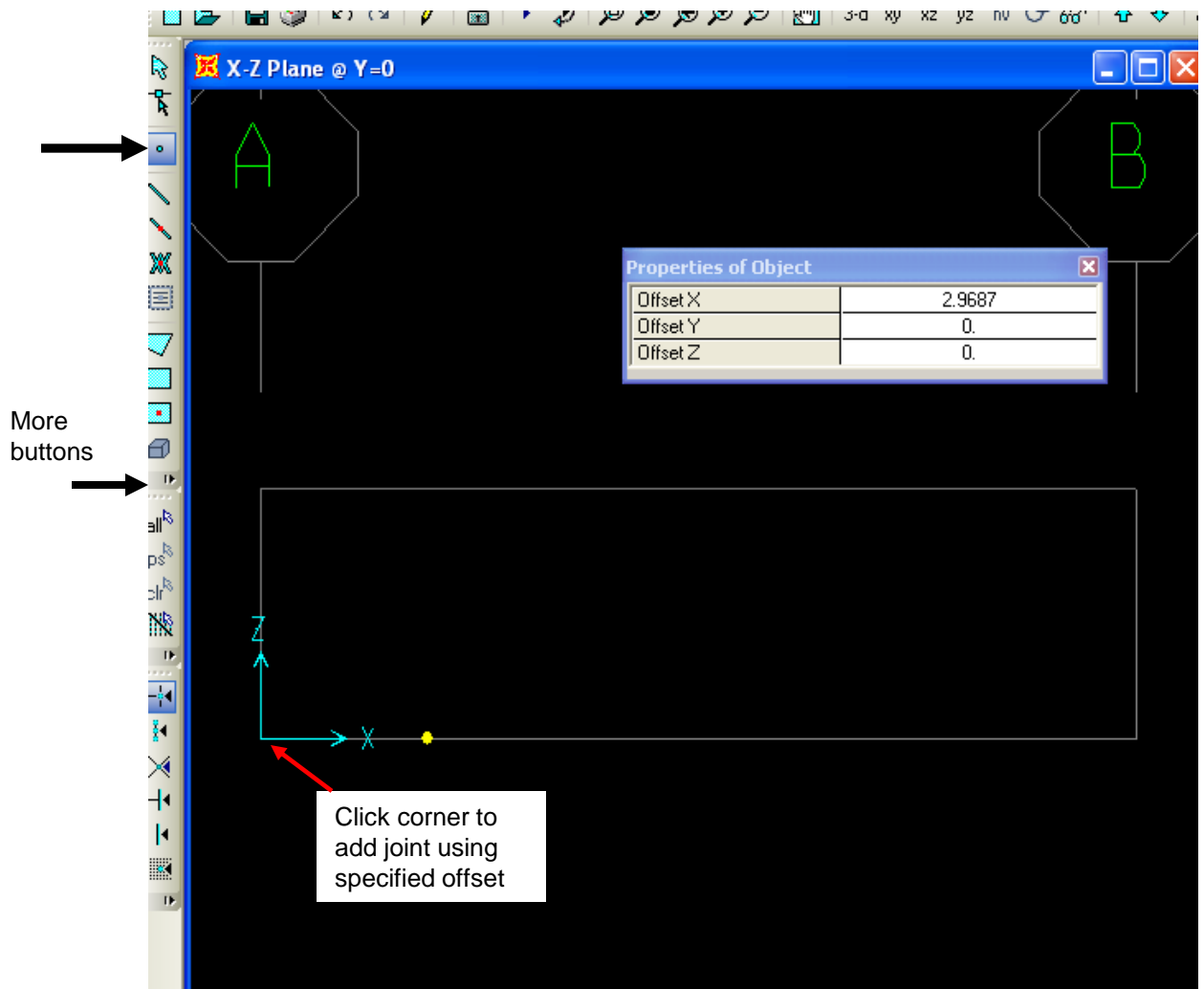

Keeping the offset the same, click the joint we just added to add another joint with the same offset. Next, change the Offset X to 3.792 per the truss drawing and click the joint we just added to add a 3rd joint

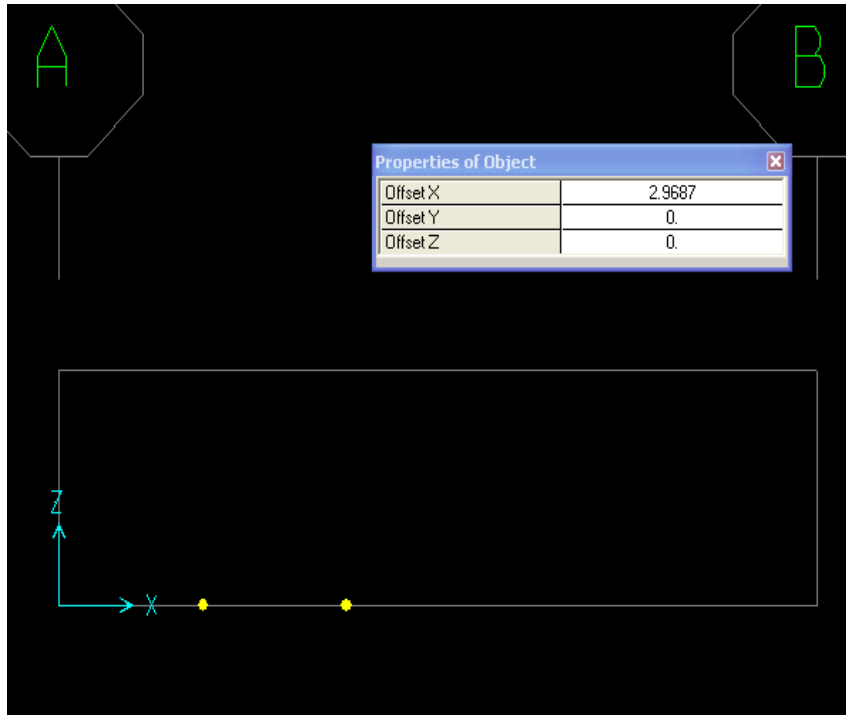

Special joints can be offset from any existing joint or grid intersection

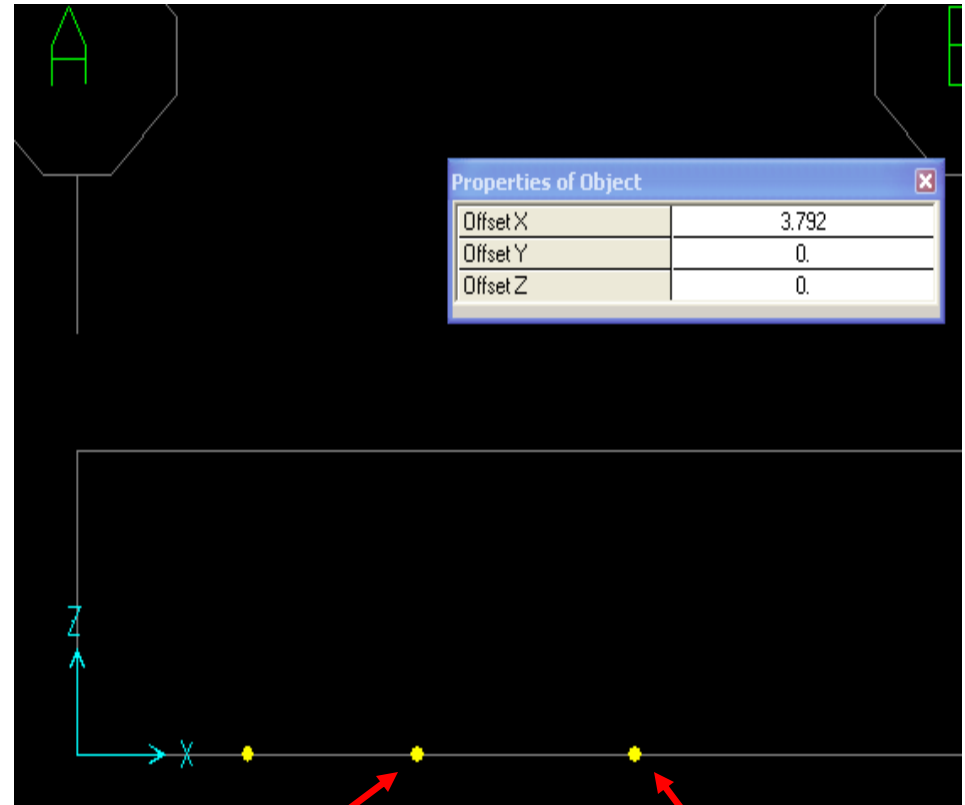

Now type 2.9687 in Offset X and click the point we just added. Press Esc key on your keyboard or press Select button  to switch to select mode. While holding down your left mouse key, window around the two middle joints, then using the main menu go to Edit>Replicate. Type 4.453 in the dz field (height of truss) and press OK.

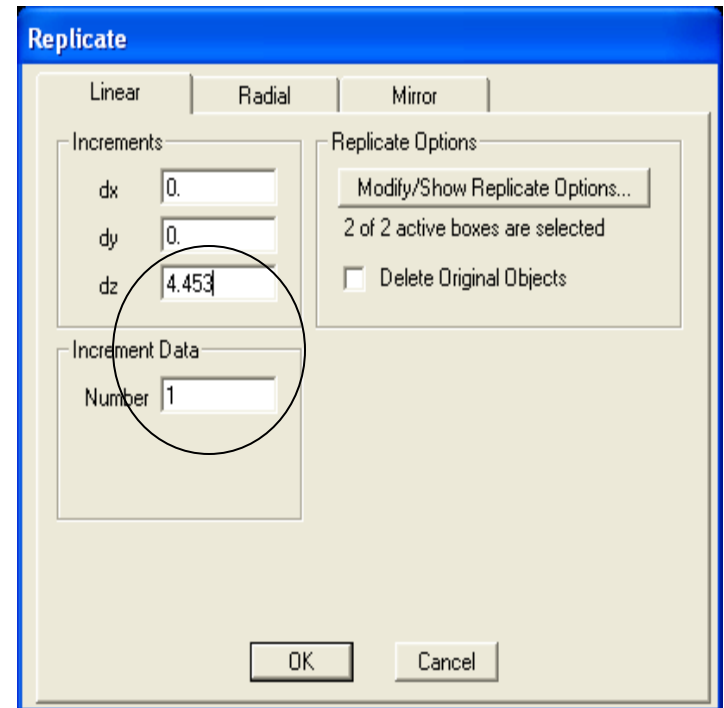
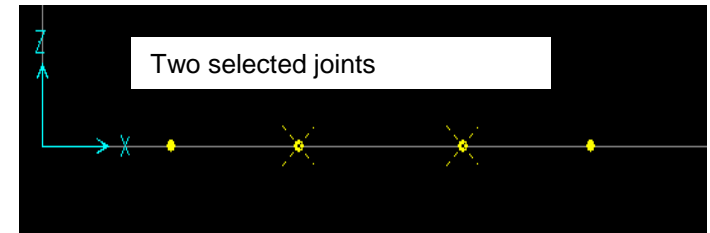
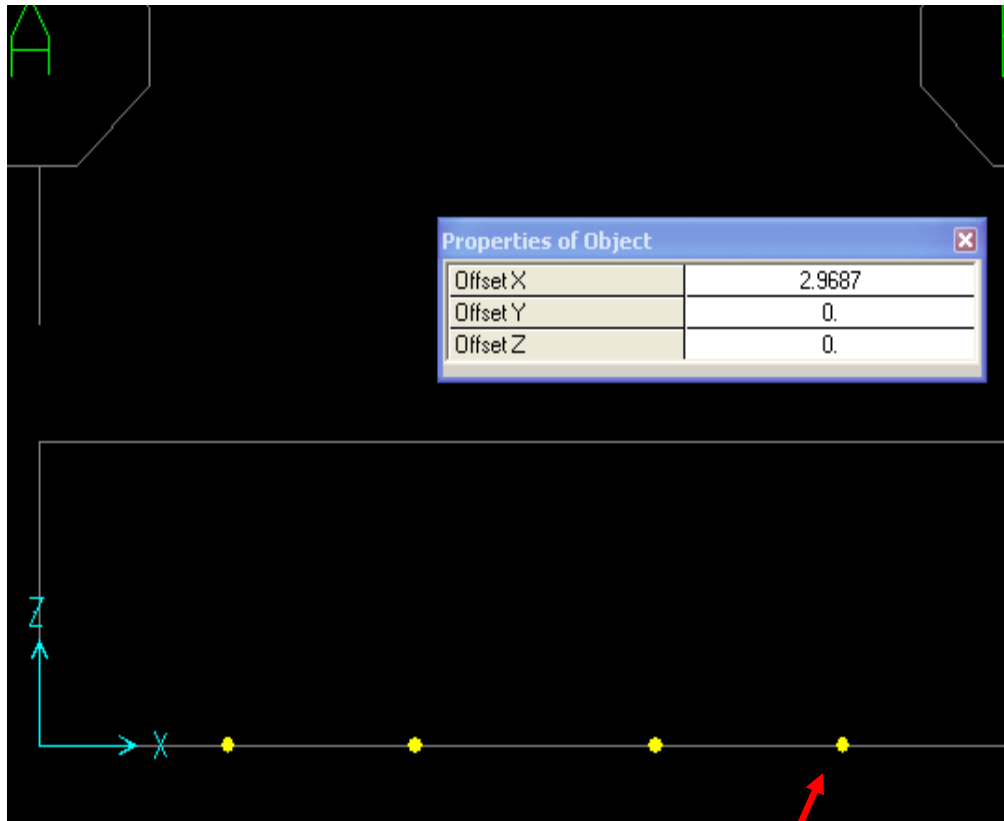

Newly added joint

Below left is what your model should look like now. Double click any gridline with your mouse or use Define menu>Coordinate system/grids to display the Define grid system data dialogue shown below right. Add X gridlines for -1 and 16.6667 and -.75 in the Z grid as shown to help us draw the sloped chord, then press OK to accept

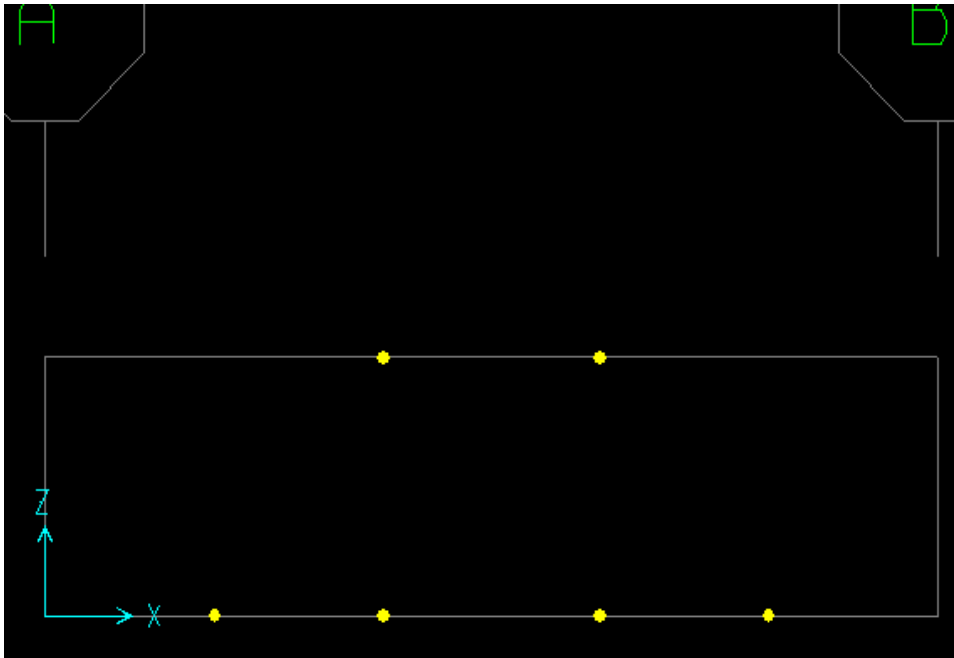

Define Grid System Data

Edit Format

System Name: GLOBAL Units: Kip, ft, F

Grid Lines: Quick Start...

-X Grid Data

	Grid ID	Ordinate	Line Type	Visibility	Bubble Loc.	Bubble Loc. ▲
1	A	0	Primary	Show	End	
2	B	15.6667	Primary	Show	End	
3		-1				
4		16.6667				
5						
6						
7						
8						

-Y Grid Data

	Grid ID	Ordinate	Line Type	Visibility	Bubble Loc.	Bubble Loc. ▲
1	1	0	Primary	Show	Start	
2						
3						
4						
5						
6						
7						
8						

-Z Grid Data

	Grid ID	Ordinate	Line Type	Visibility	Bubble Loc.
1	Z1	0	Primary	Show	End
2	Z2	4.453	Primary	Show	End
3		-.75			
4					
5					
6					
7					
8					

Display Grids as: Ordinates Spacing

Hide All Grid Lines
 Glue to Grid Lines

Bubble Size: 3.5

Reset to Default Color
Reorder Ordinates

OK Cancel

With SAP2000, you can build your model and later come back to define and assign section properties, or draw and assign section properties at the same time. The order doesn't matter, so we'll do it both ways in this tutorial. First, click Draw frame/cable button as shown, use default FSEC1 section and continuous connection, and click once in the bottom left corner of the grid and double click on the top joint as shown to draw one sloped chord. Snapping to grid intersections and joints is typically how most models are created in SAP2000.

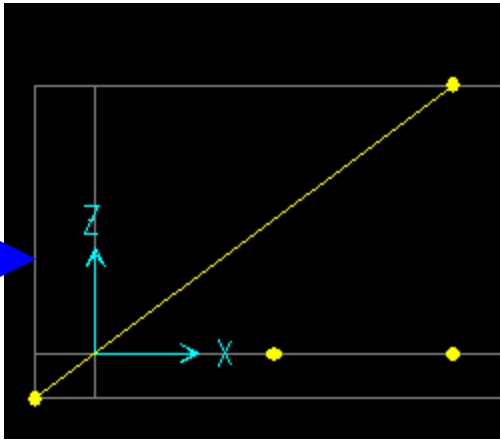
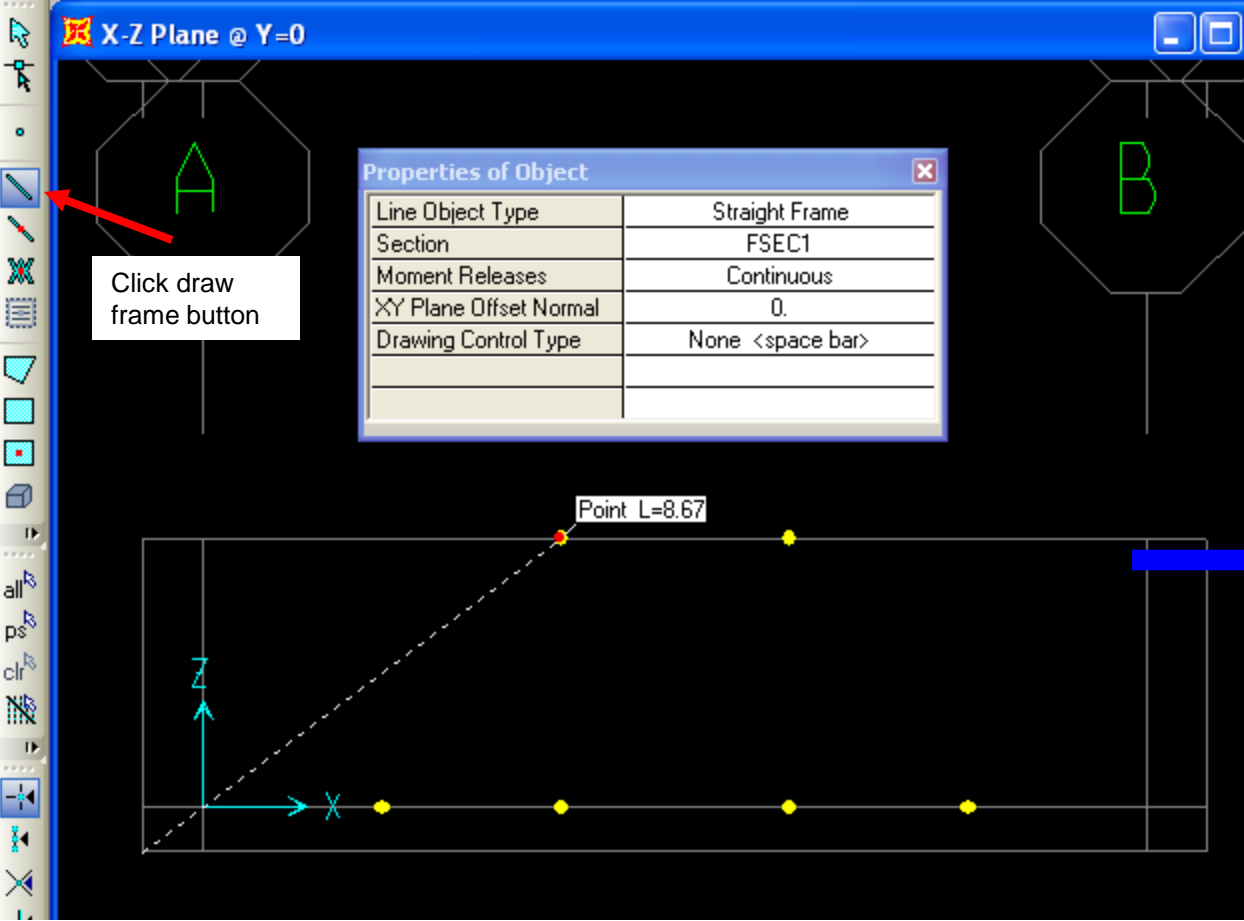

Next, use the main menu to Define>Section properties>Frame sections. To define cold form steel sections, concrete sections, or nonstandard steel sections, always click the 'Add New property' button. For standard steel shapes, you would click the 'Import New property' button to select a steel library in order to import sections. In this example, we're using cold form sections, so click the 'Add new property' button. Change Frame Section property type to Cold Formed as shown below right and click the C section to define.

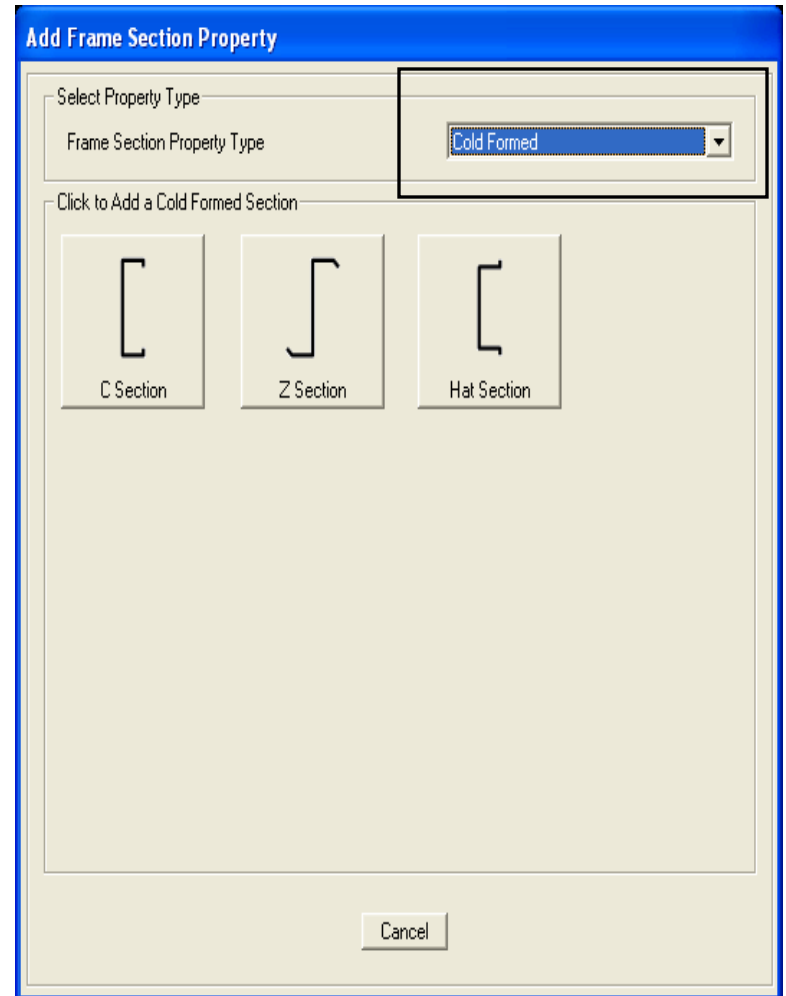
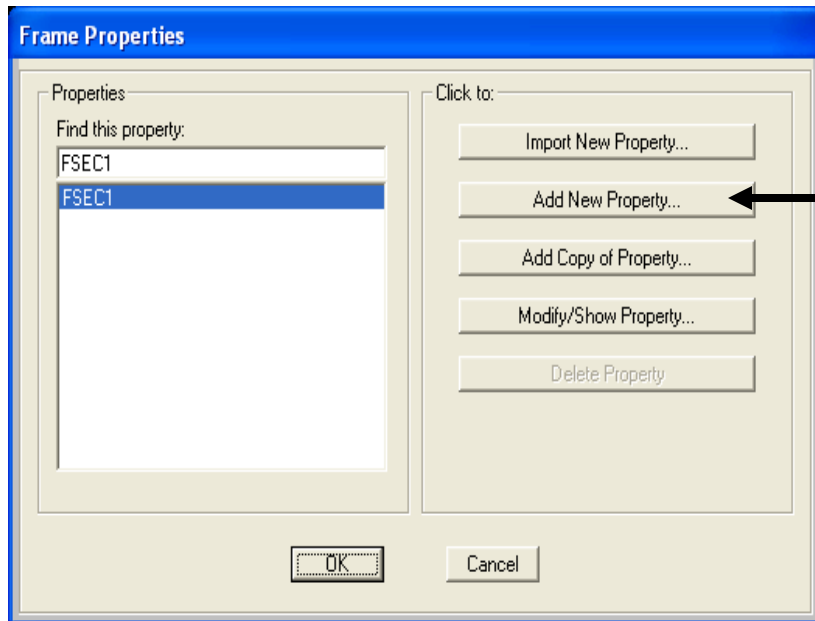

Here we change the section name to whatever we want and type in the dimensions as shown. It may have been a little more convenient to switch units (bottom right corner of SAP2000) to Kip-inches before defining sections, but as you can see below, SAP will accept inch dimensions if you use the " mark after the value as shown below in the Outside Width field. We will accept the default cold form material. For future reference, please note that by clicking the "+" sign next to the material, that would open a dialogue to define additional materials which could be used on any section. But for this example we will accept the default material. Input dimensions as shown and press OK to accept in order to add it to the working list.

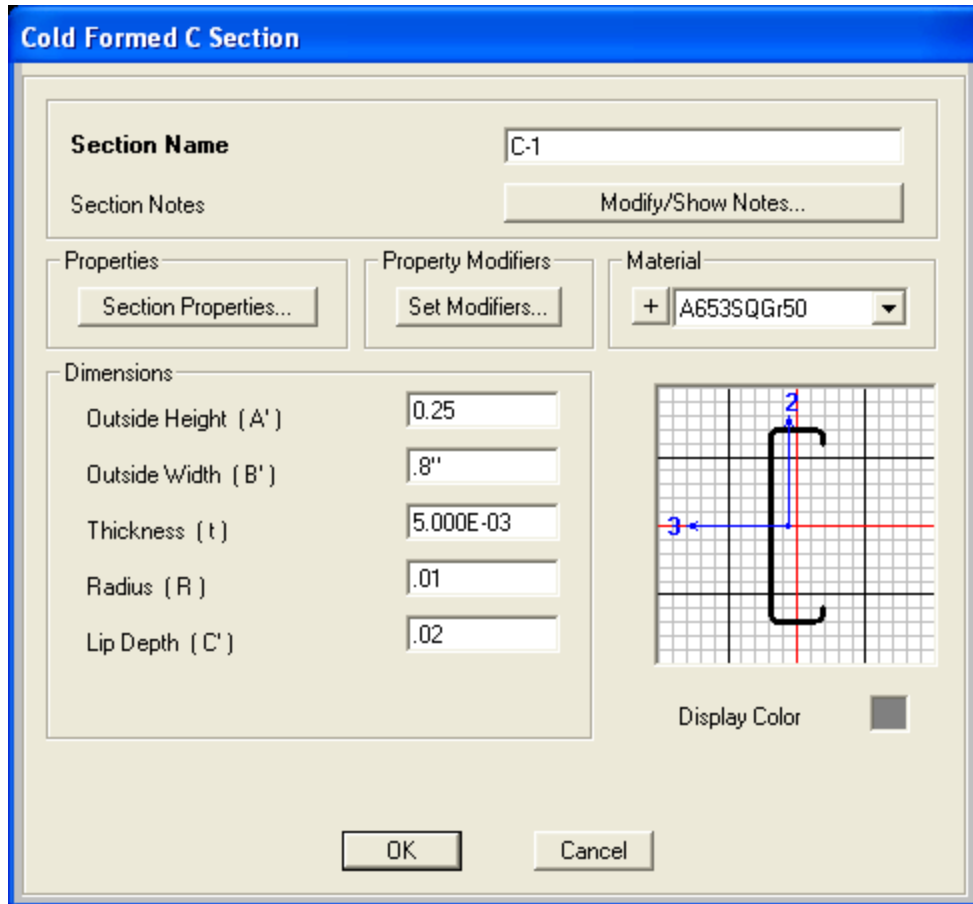

Cold Formed C Section

Section Name C-1

Section Notes

Properties

Property Modifiers

Material + A653SQQr50

Dimensions

Outside Height (A')	0.25
Outside Width (B')	.8"
Thickness (t)	5.000E-03
Radius (R)	.01
Lip Depth (C')	.02

Display Color

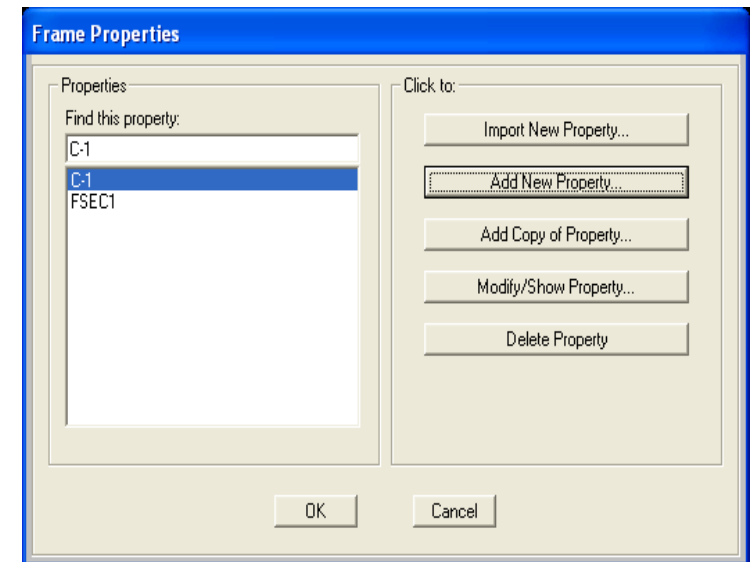

Frame Properties

Properties

Find this property:

- C-1
- C-1
- FSEC1

Click to:

Click 'Add new property' button to add another cold formed frame type. This time click to add a hat section, name it as shown and type dimensions as shown, then press OK to add. Press OK on Frame properties dialogue to begin modeling.

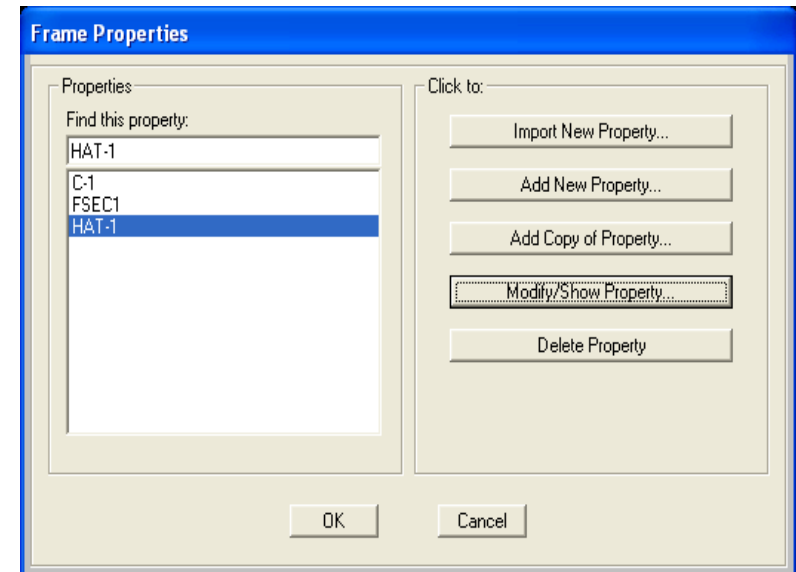
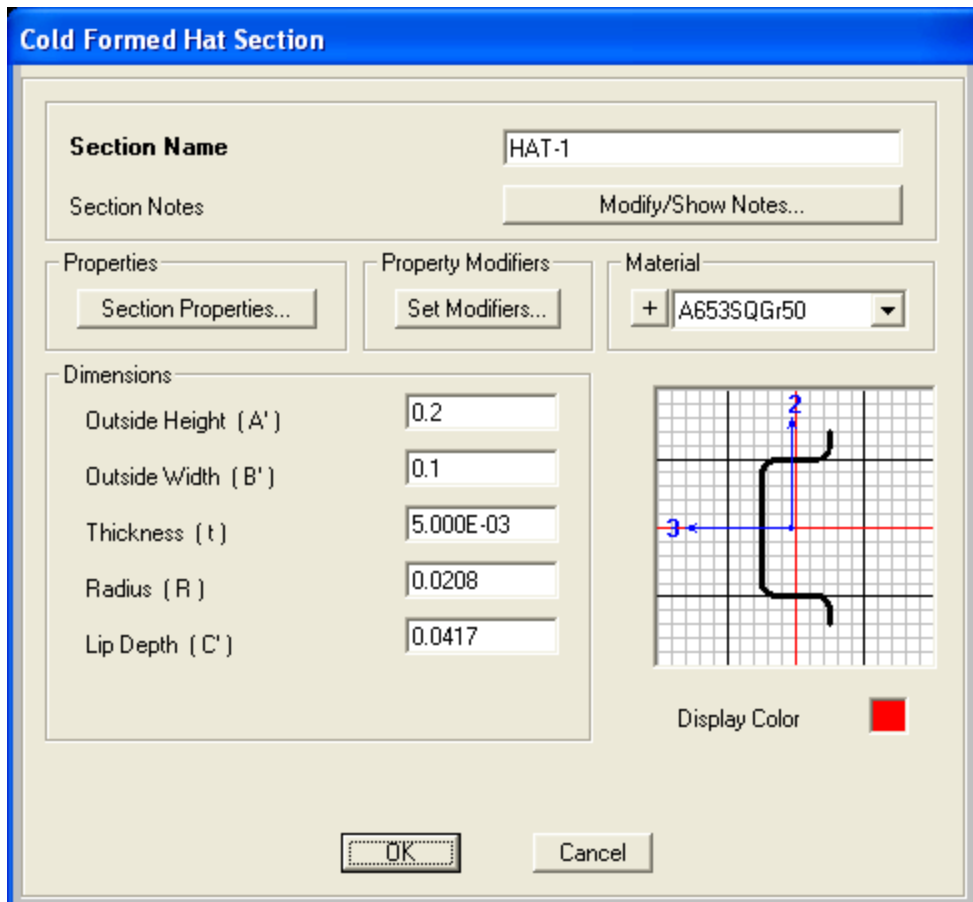

Click Draw frame/cable button again, but this time on the floating property dialogue click the Section with your mouse to select C-1 as shown with continuous connection and click once in the bottom right corner as shown, then double click the mouse at top to draw the other sloped chord.

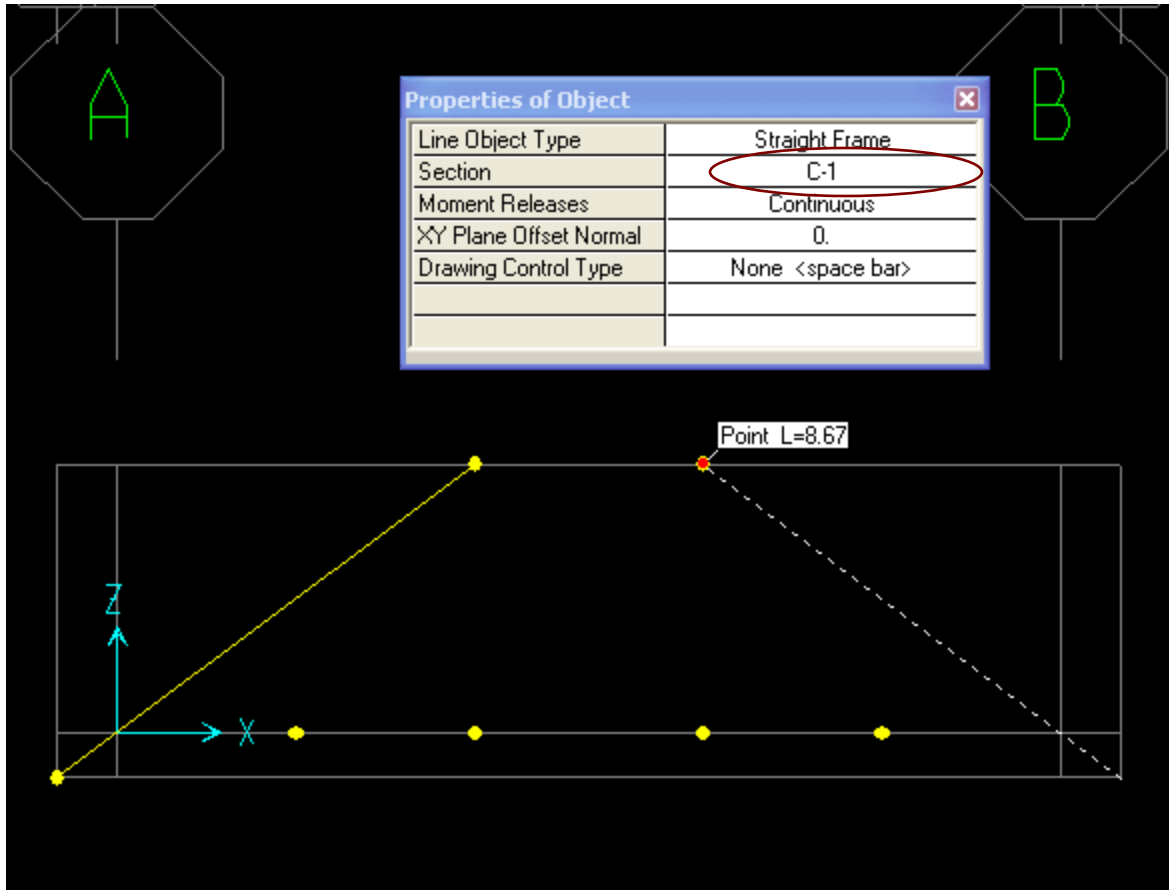

Next, draw another C-1 frame section between the two joints as shown, but before drawing, click to change Moment releases to Pinned as shown

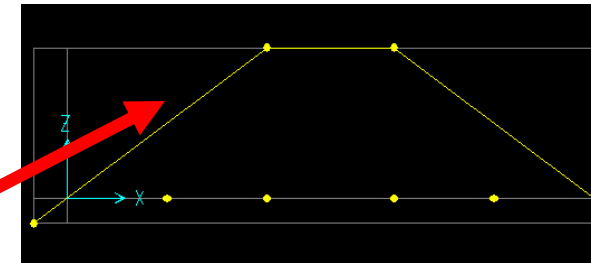
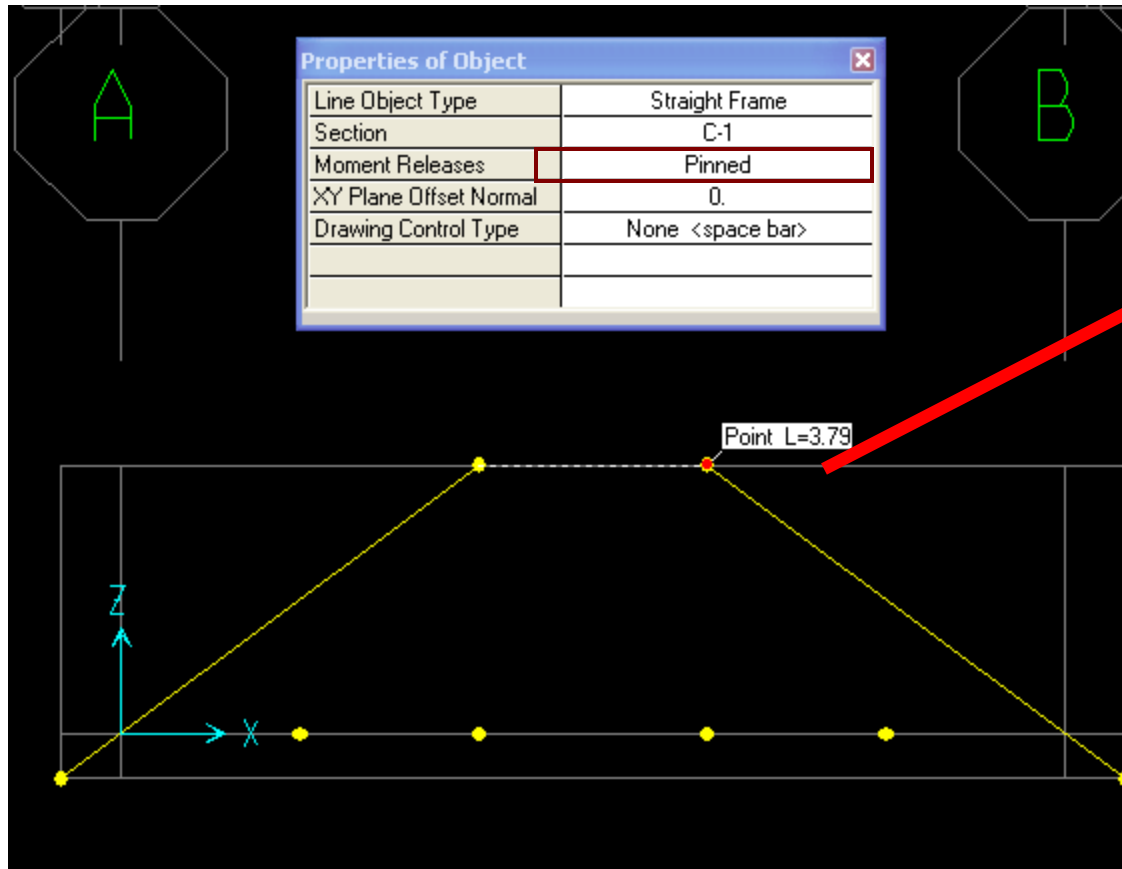

Click to switch moment releases back to continuous and draw the bottom chord as shown below, drawing it as one long member. Use the grid intersections to help you snap, since the snap to points and grid intersections button is activated by default

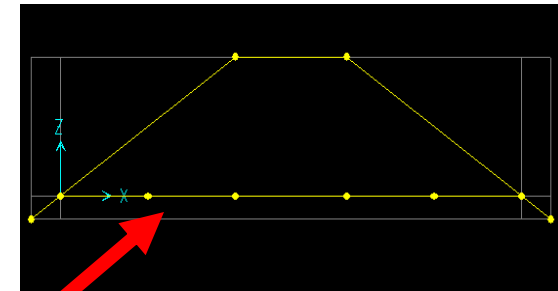
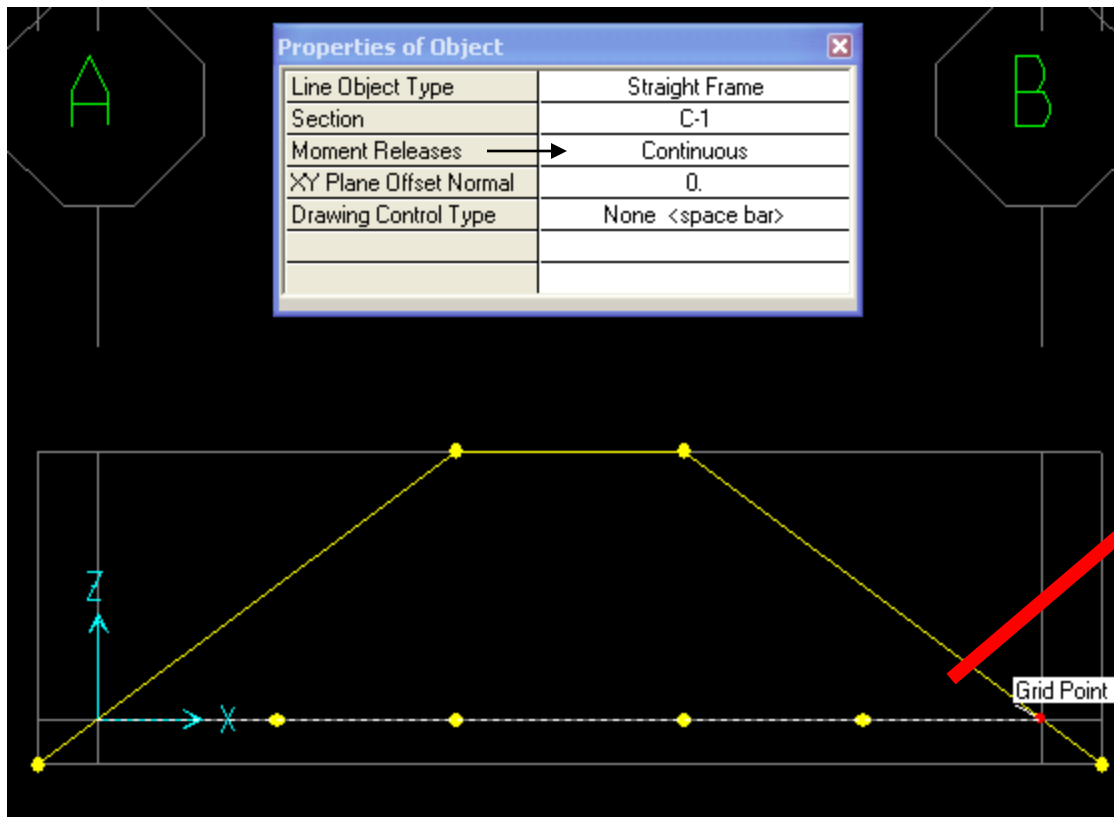

Draw the bottom chord as one long member. Click once on the far left and double click once on the far right as shown

Click the 'snap to lines and edges' snap tool as shown below, change the section to HAT-1 and moment releases to Pinned, then draw frame starting at bottom joint. As soon as you begin to draw, type the letter V on your keyboard to lock the draw frame onto vertical only as shown. As soon as you see the line tool tip as shown which indicates the intersection with the sloped chord, click again to complete the vertical brace

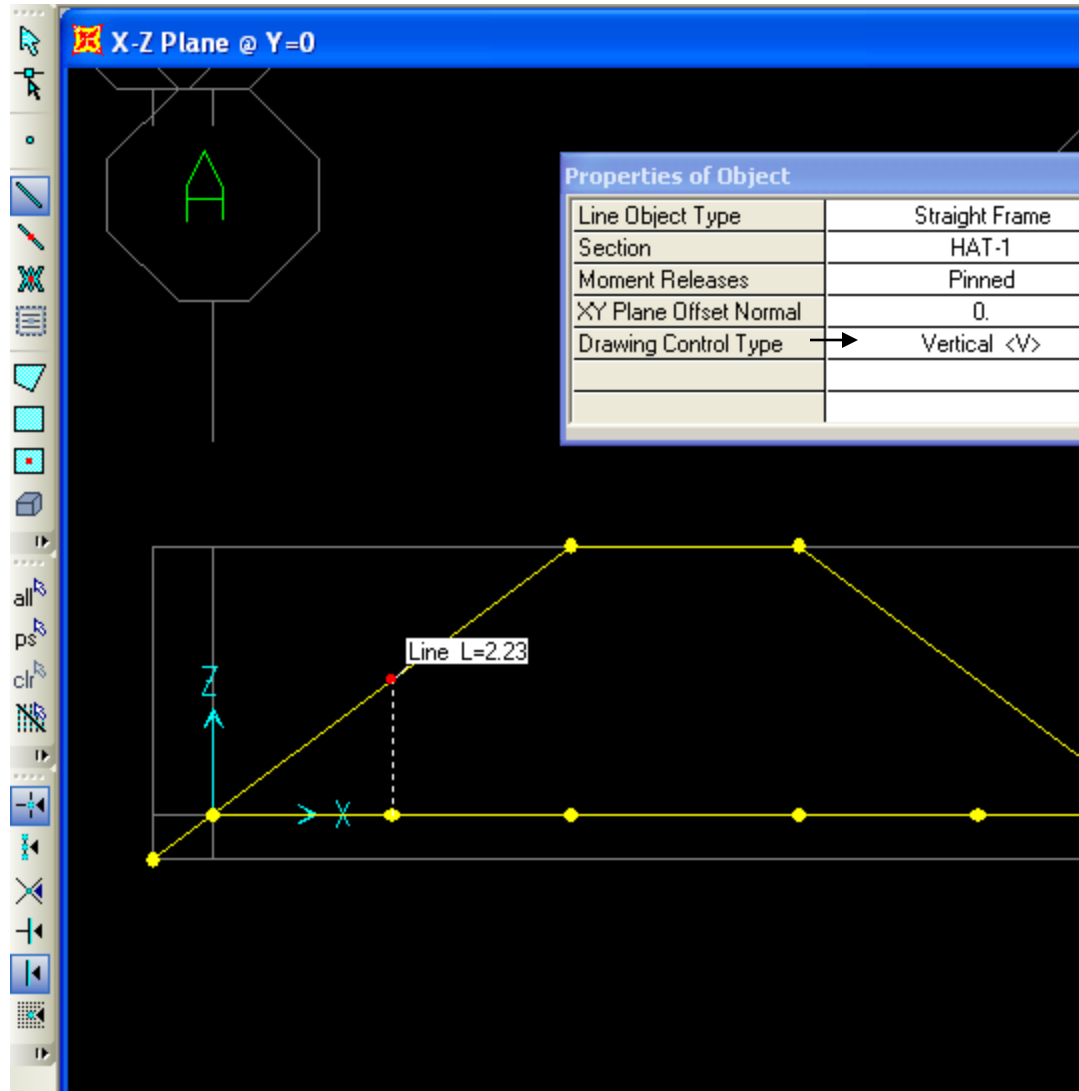

Snap to
lines and
edges

Continue drawing as shown to connect the dots using the same HAT-1 section with pinned releases. After drawing the vertical brace, right mouse click to draw at another location at the bottom as shown.

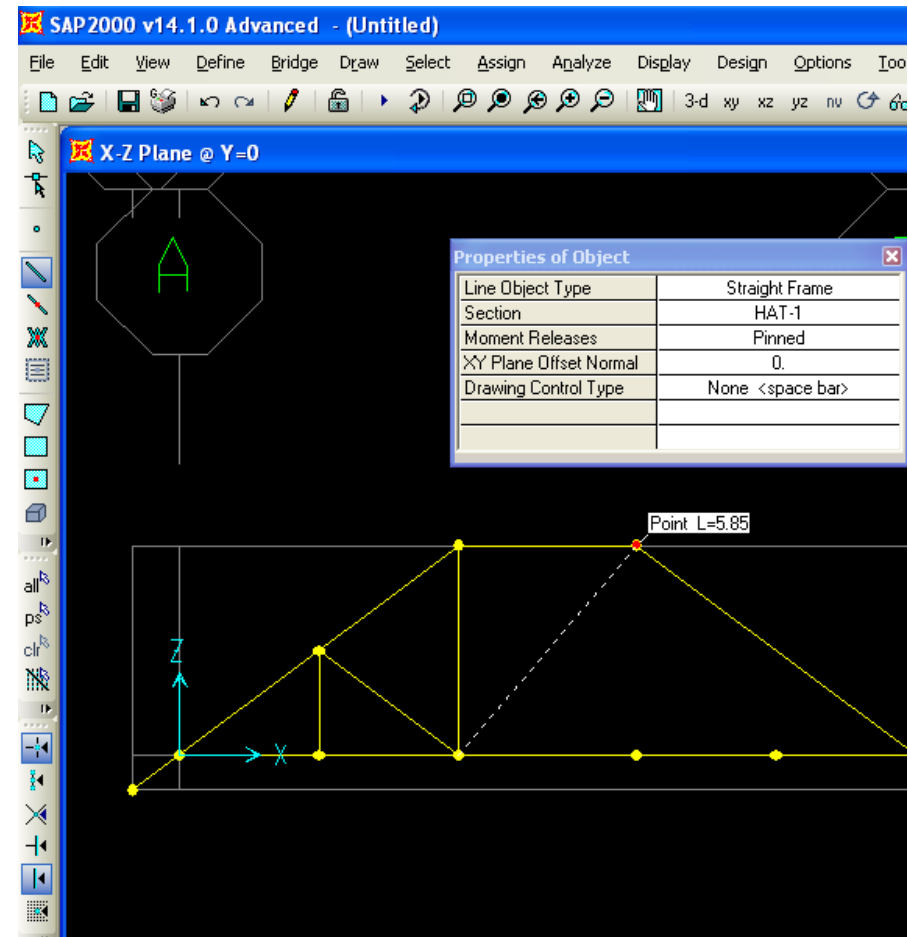
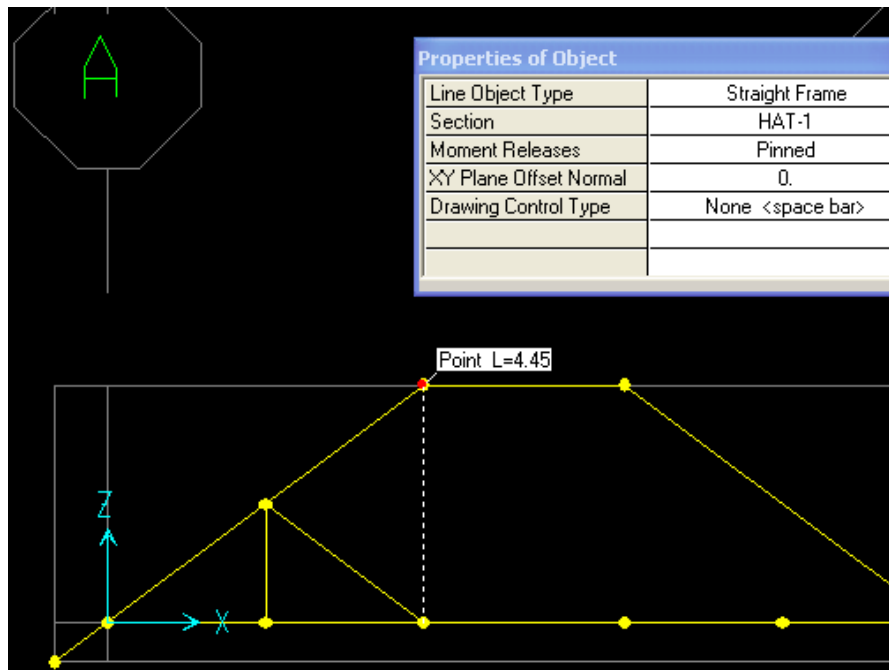

Draw as shown from the bottom chord upward typing V on the keyboard as before to lock on to the sloping line where you click to draw the vertical brace. Then draw from that point down to the base of the next vertical bracing as shown bottom right. Press Esc key on your keyboard or click Select button to exit draw mode.

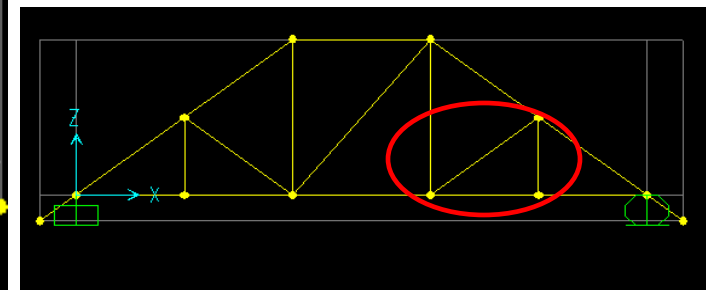
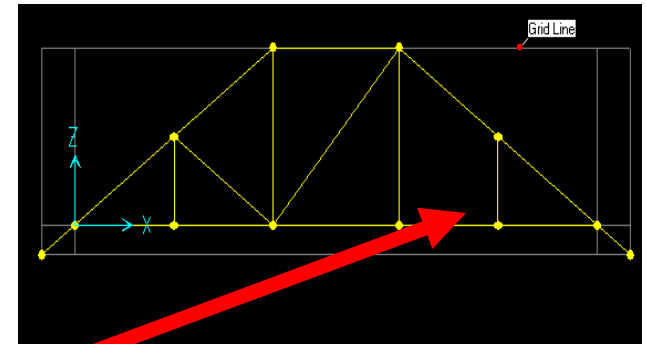
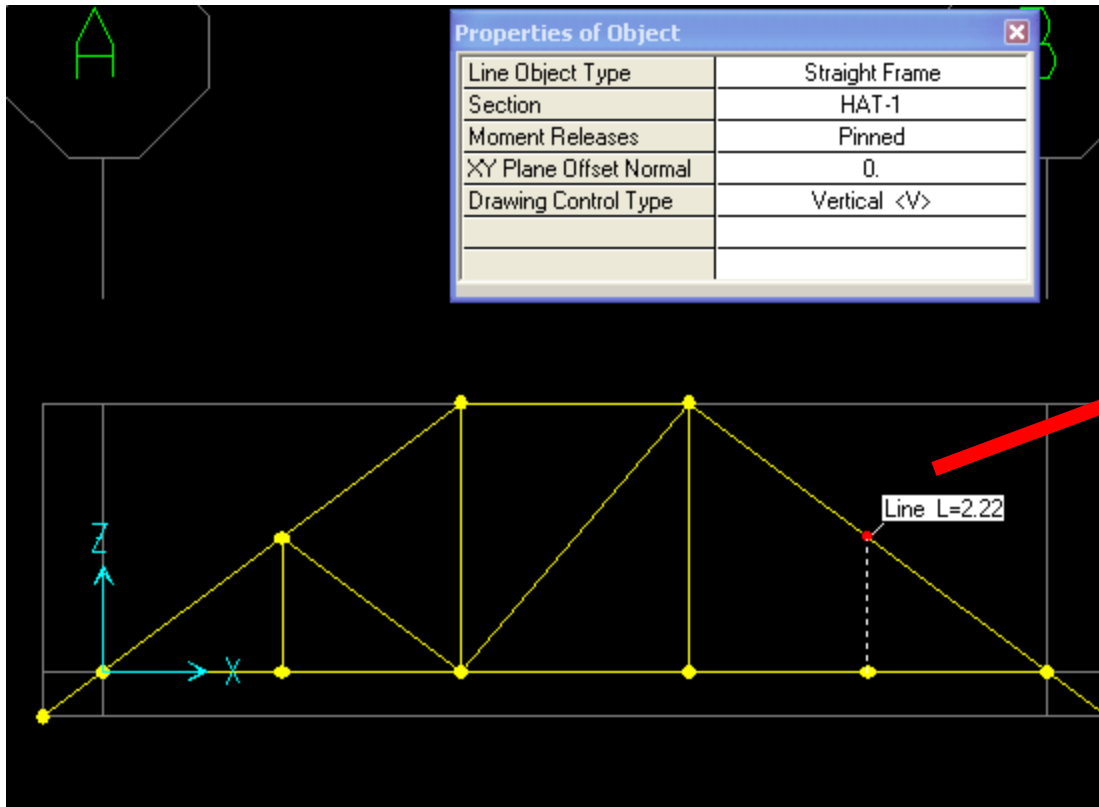

Draw final brace as shown

Click anywhere in the 3D view window to make it active, then click 'set display options' button and check 'Extrude view' as shown to render the model in 3D view. As we can see, the initial sloped chord that we drew needs to be re-assigned a new section, and we may have to rotate local axes of frames. Extruded view is a useful tool for checking errors in section assignments and local axes.

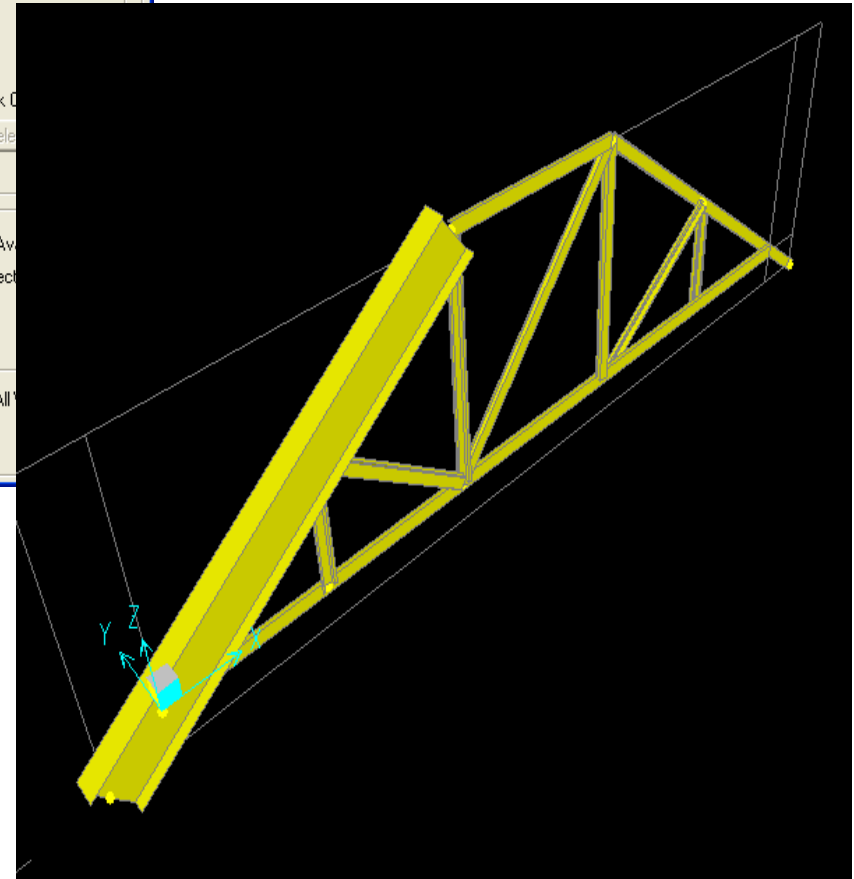
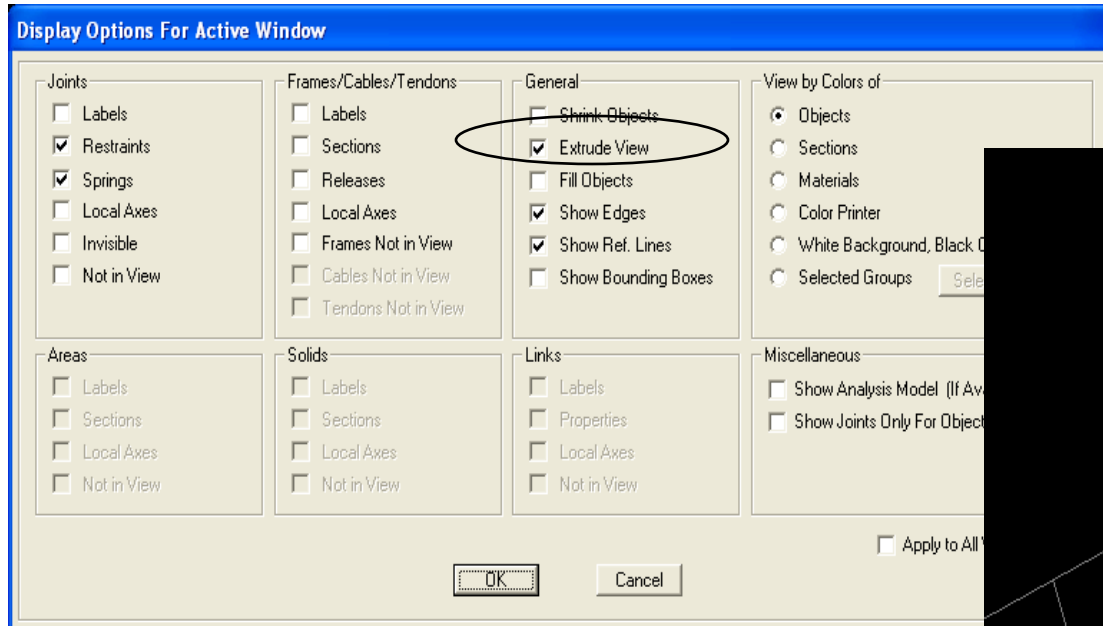

Set Display options are also useful to graphically view moment releases of frames as well as view local axes and labels.

Click FSEC1 frame section to select it, then from main menu Assign>Frame>Section, highlight C-1 as shown and press OK to assign a new section to it.

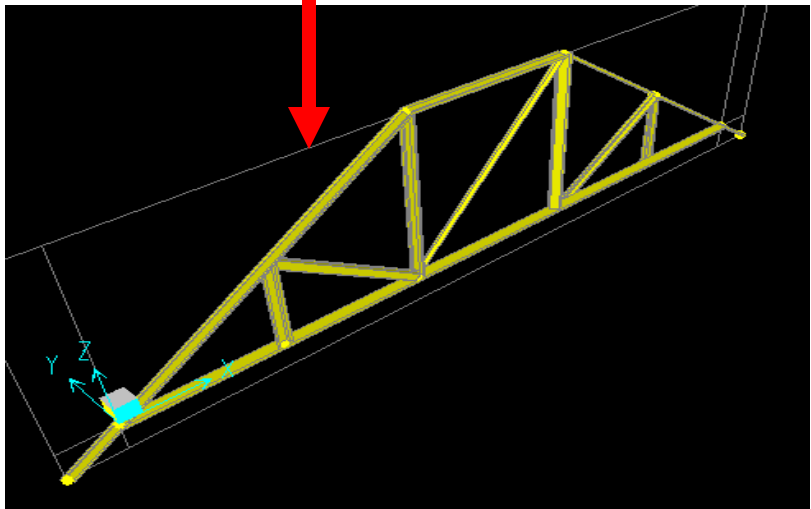
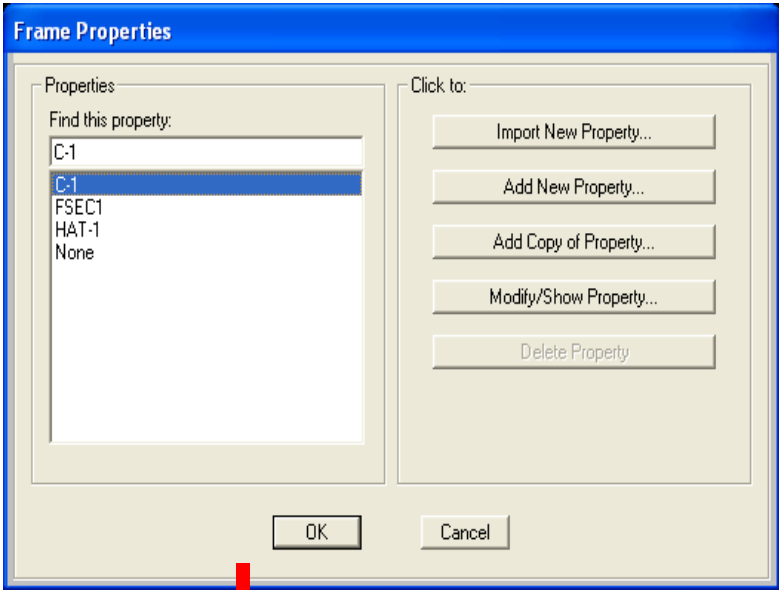
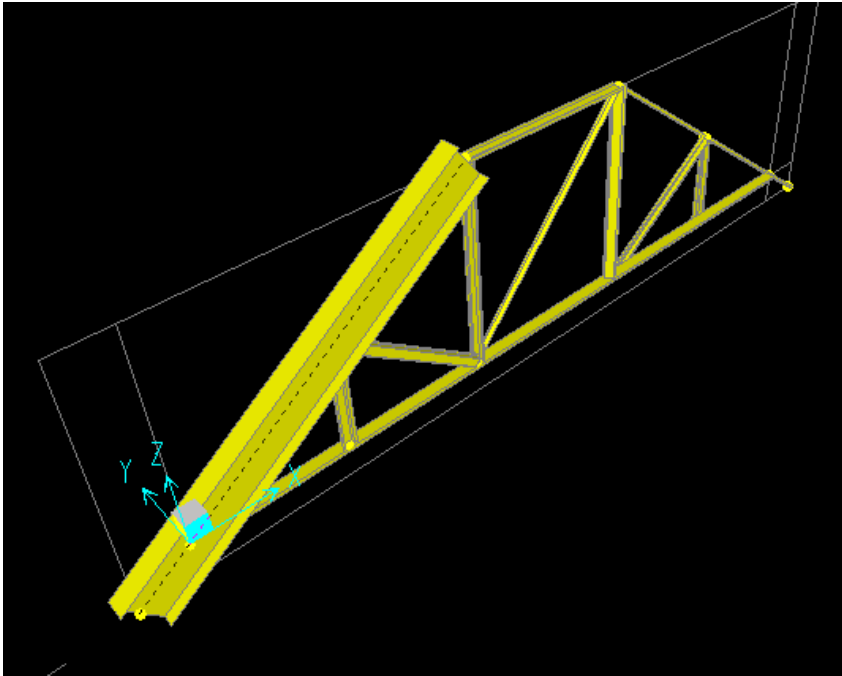

Click window zoom button and window around the horizontal top chord to zoom in to view local axis. Click the two sloped chords and the horizontal chord as shown to select, then Assign>Frame>Local axes, type -90 degrees and press OK to rotate as shown

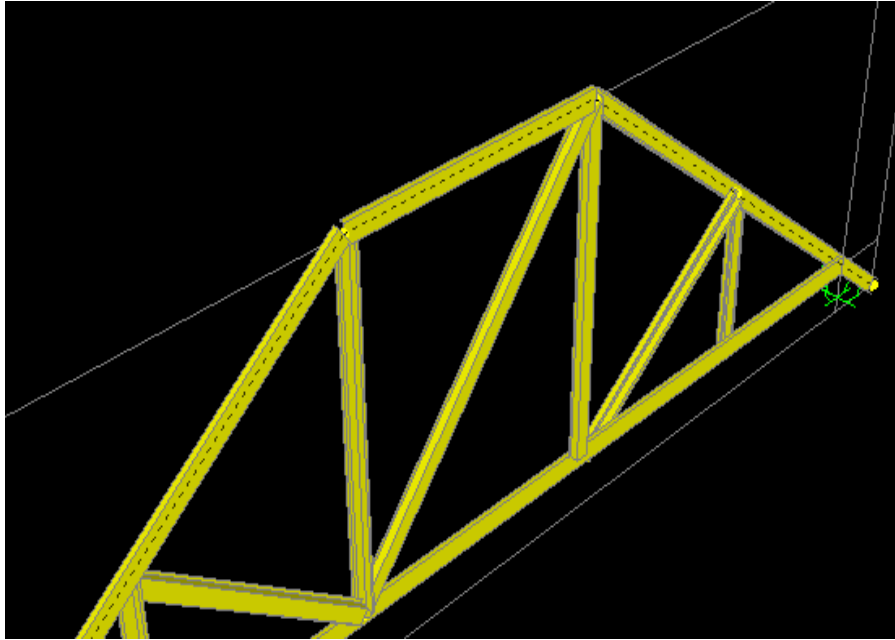

All 3 top chord members selected

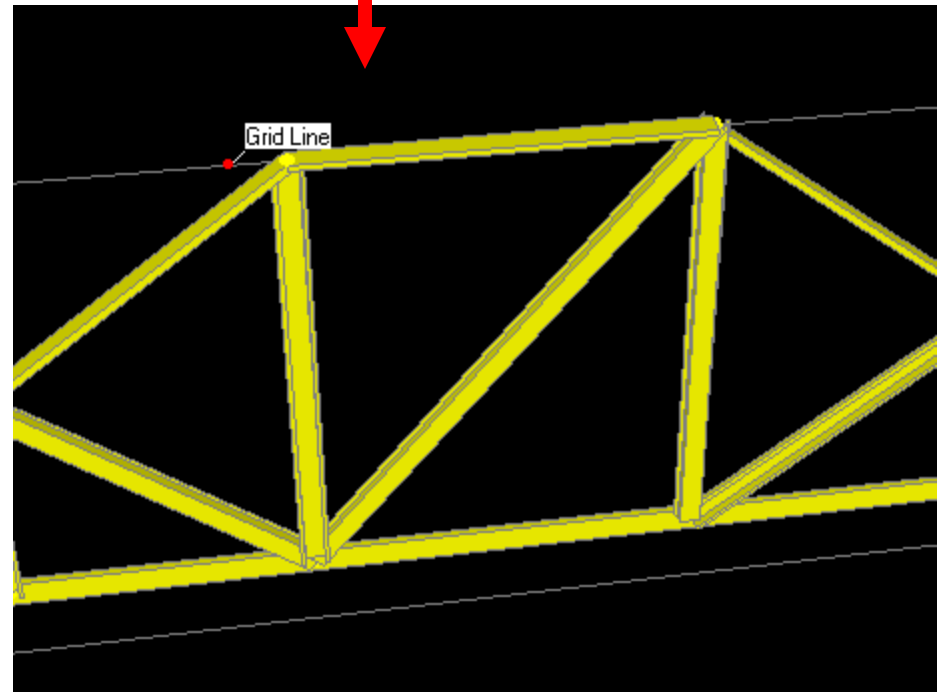
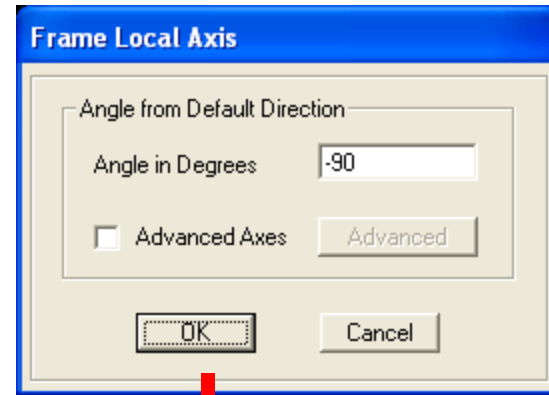

Click to select bottom chord and Assign>Frame>Local axes, but this time, rotate positive 90 degrees. Use this assignment to rotate local axes of any frame members. For information purposes and future reference only, note that the Assign>Frame menu can also be used to assign end releases and partial fixity as shown below right. For this tutorial, we handle releases by choosing *Pinned* or *Continuous* from the floating properties dialogue whenever we draw members.

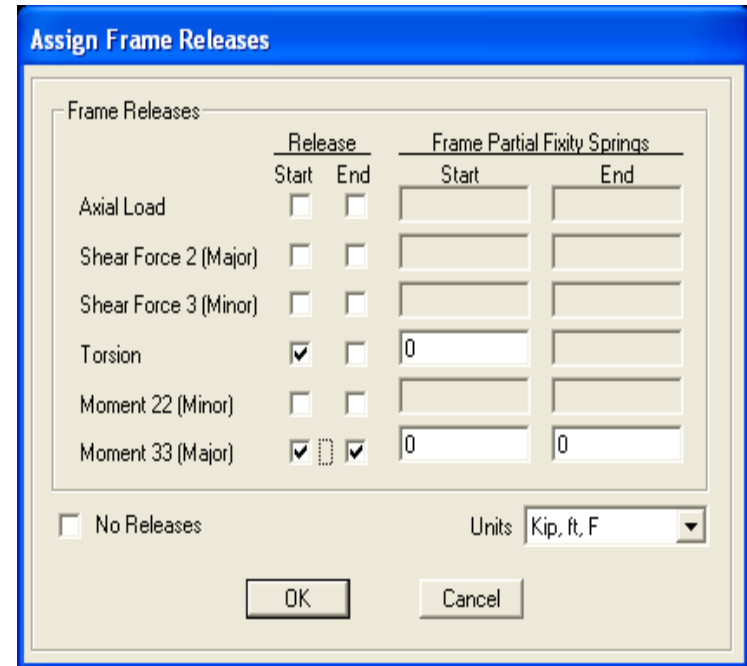
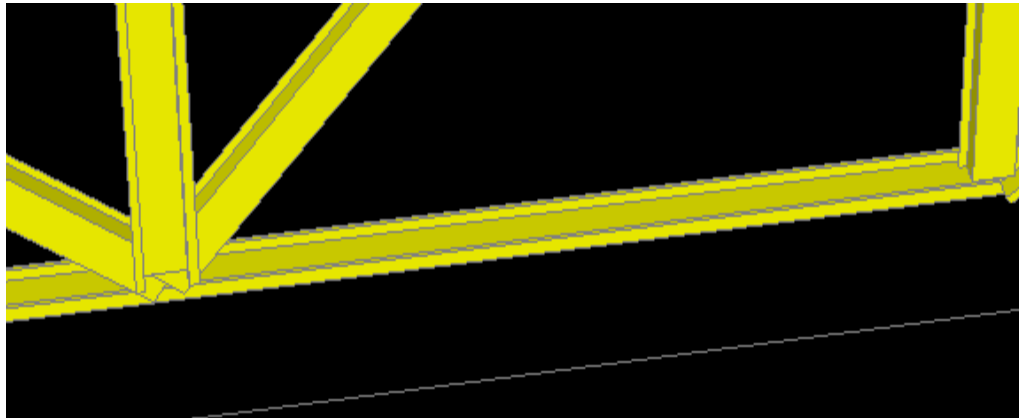
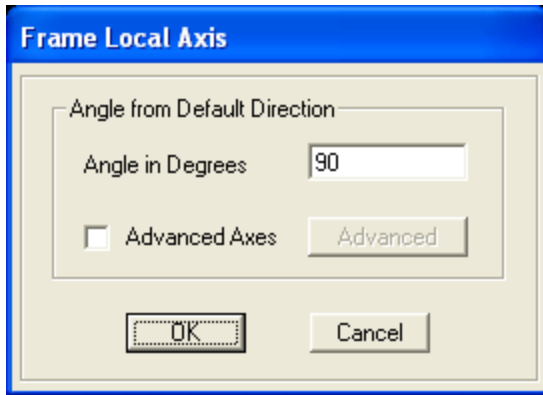

End releases in each direction can be modified at any time by selecting members and Assign>Frame>Releases/partial fixity. The partial fixity option applies only if you have data on the stiffness of the end connection.

Next step is to add restraint supports. Select the lower left joint shown below and Assign>Joint>Restrains to add a fixed restraint as per the drawing. Then select lower right side joint and assign a roller type support in the vertical direction as per the drawing.

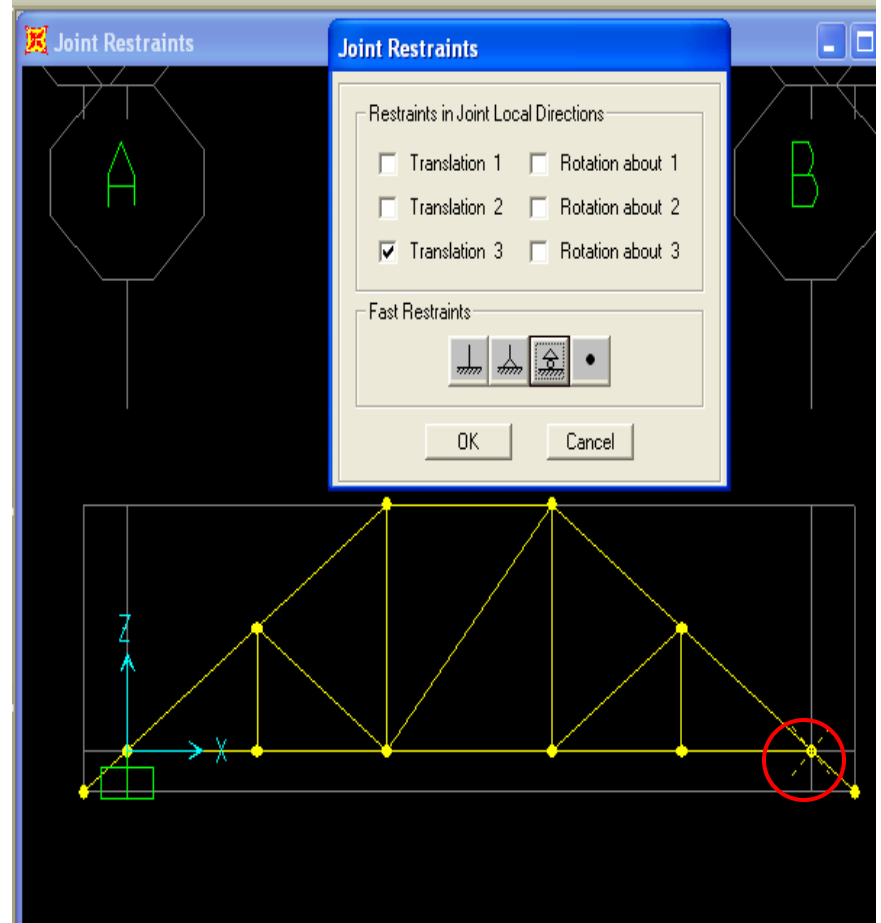
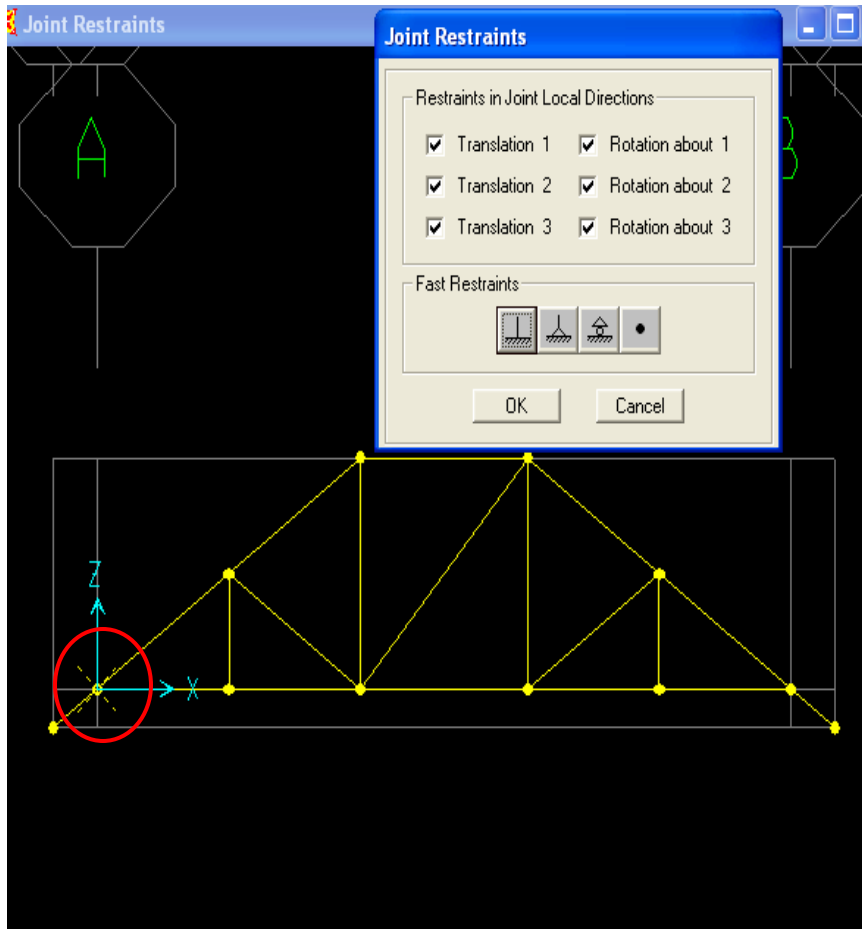

In some cases, designers may not want to consider a roller or pinned joint restraint to be 100% free in the non-supported directions. In situations like that, the designer can select the joint(s) and add springs by using Assign>Joint>Springs if partial fixity or joint flexibility is to be considered. Next, let's assign loads to the truss. Select the top horizontal chord and Assign>Frame loads>Distributed, which brings up a Distributed load dialogue with default load case. In this example, we will add an additional load case. Click the "+" to the left of DEAD which displays the Define Load Patterns. Overwrite the Load pattern name to be Distributed, type LIVE as shown, then press 'Add new load pattern' button.

Joint Springs

Spring Direction
Coordinate System: GLOBAL

Spring Stiffness
Translation Global X: .1
Translation Global Y: 0
Translation Global Z: 0
Rotation about Global X: 0
Rotation about Global Y: .2
Rotation about Global Z: 0

Options
 Add to Existing Springs
 Replace Existing Springs
 Delete Existing Springs

Advanced...
OK Cancel

Users can assign joint springs to supplement or replace restraint assignments

Joint Restraints

Frame Distributed Loads

Load Pattern Name: + DEAD Units: Kip, ft, F

Load Type and Direction
 Forces Moments
 Coord Sys: GLOBAL
 Direction: Gravity

Options
 Add to Existing Loads
 Replace Existing Loads
 Delete Existing Loads

Trapezoidal Loads
 1. 2. 3. 4.
 Distance: 0. 0.25 0.75 1.
 Load: 0. 0. 0. 0.
 Relative Distance from End-I Absolute Distance from End-I

Uniform Load
 Load: 0. OK Cancel

Define Load Patterns

Load Patterns

Load Pattern Name	Type	Self Weight Multiplier	Auto Lateral Load Pattern
Distributed	LIVE		
DEAD	DEAD	1	

Click To:

Next step click this button to add new load pattern to the list

After pressing 'Add new load pattern', click OK to close the dialogue. Next, change Load pattern name from DEAD to Distributed, change units to lb, ft, F and type a uniform distributed load of 30 plf as shown below and the load will display graphically in current units (.03 klf). The DEAD load pattern/case by default automatically includes the selfweight of the structural members based on section and material. In this example, we are adding additional weight to the selfweight DEAD pattern

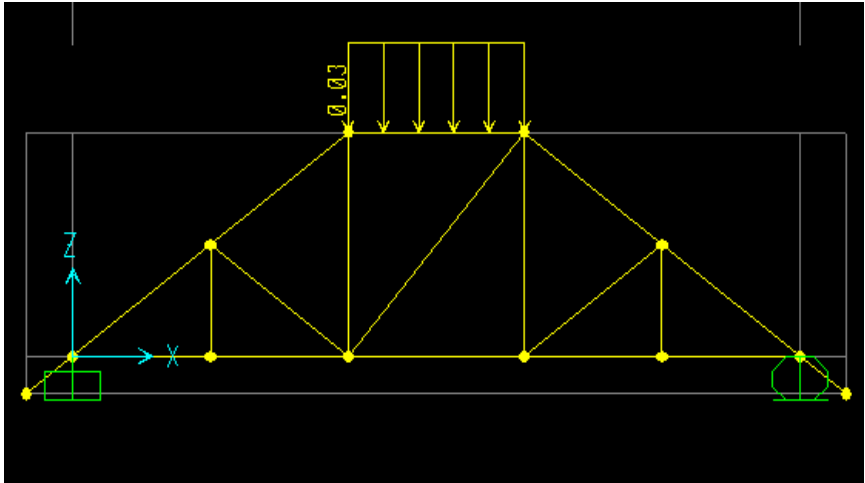
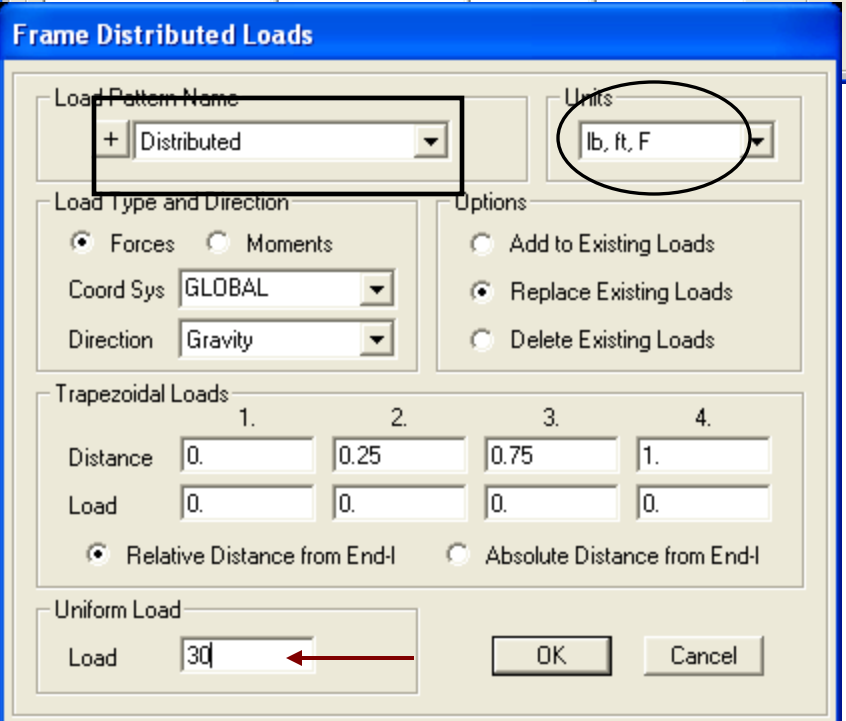
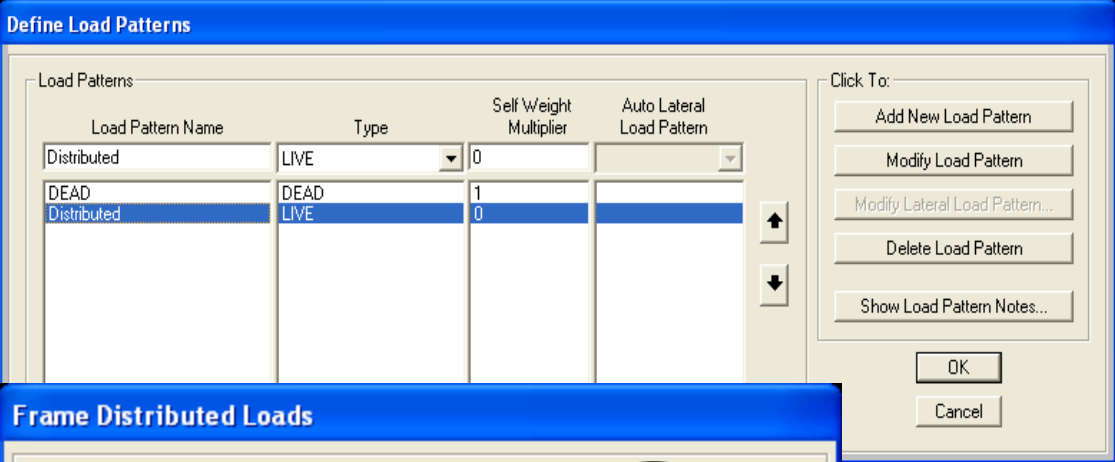

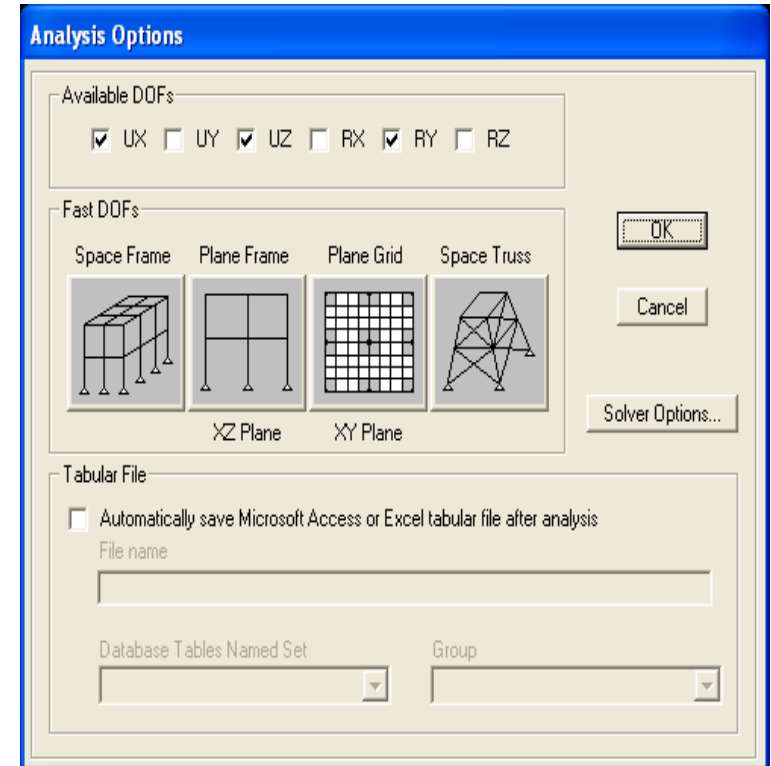
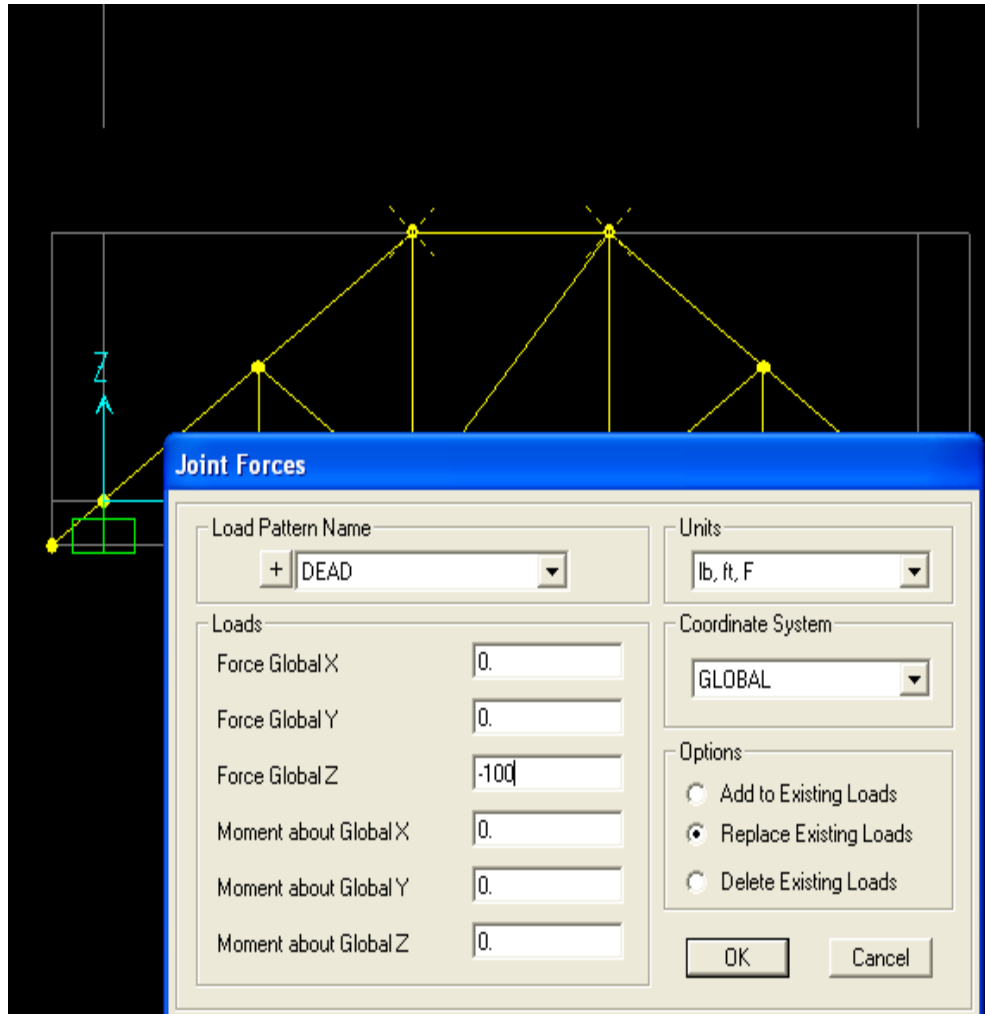

Next, we will assign joint loads by selecting the two joints at the top of the truss as shown below, then Assign>Joint loads, where we change units to lb, ft, F and assign 100lbs. in the -Z (gravity) direction under DEAD load pattern as shown below. Press OK. Now we're ready to begin analysis and AISI design. Go to Analyze menu>Set analysis options and click XZ options since we will be analyzing this truss in 2D. Press OK.

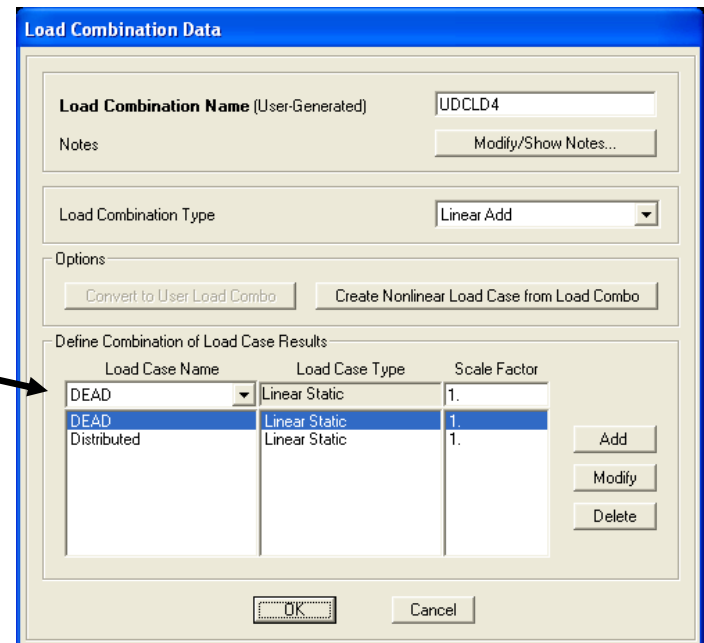
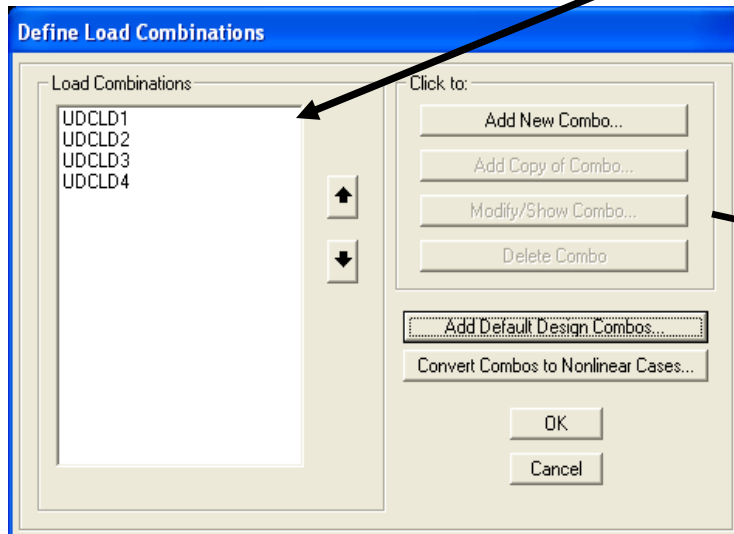
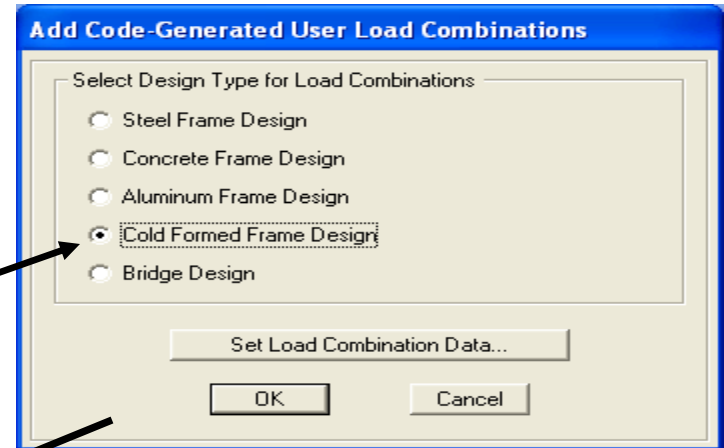
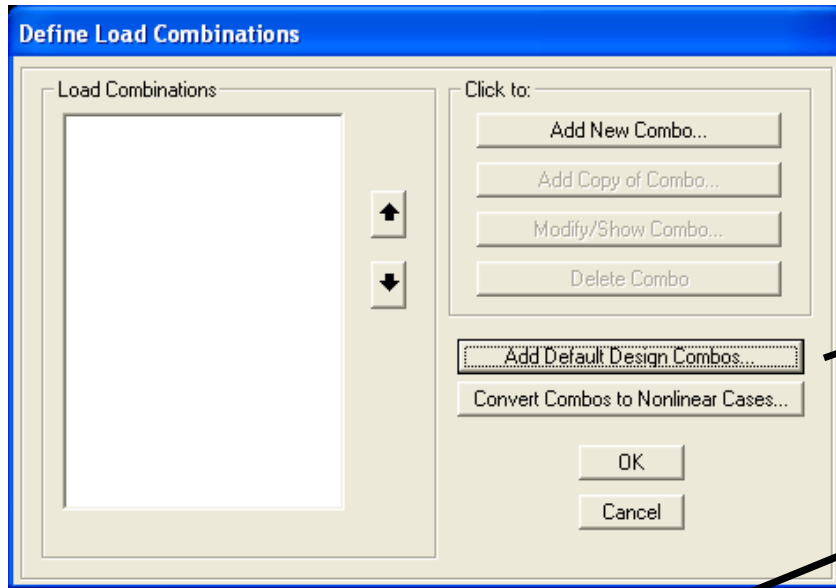

Set analysis options to run 2D as shown

Before we analyze, we need to define load combinations using Define>Load combinations. In this example, click the 'Add Default design combos' button, then select 'Cold Formed Frame design', which automatically generates load combinations for design. If you click a load combination, you can 'Modify/show' it to see details of the load combination. Alternatively, users can define their own load combinations



Click Run analysis button , then click 'Run now' button shown below. This will run the analysis to determine deflections and forces & moments based on the applied loads. You will be prompted to give the model a name, then the program will analyze.

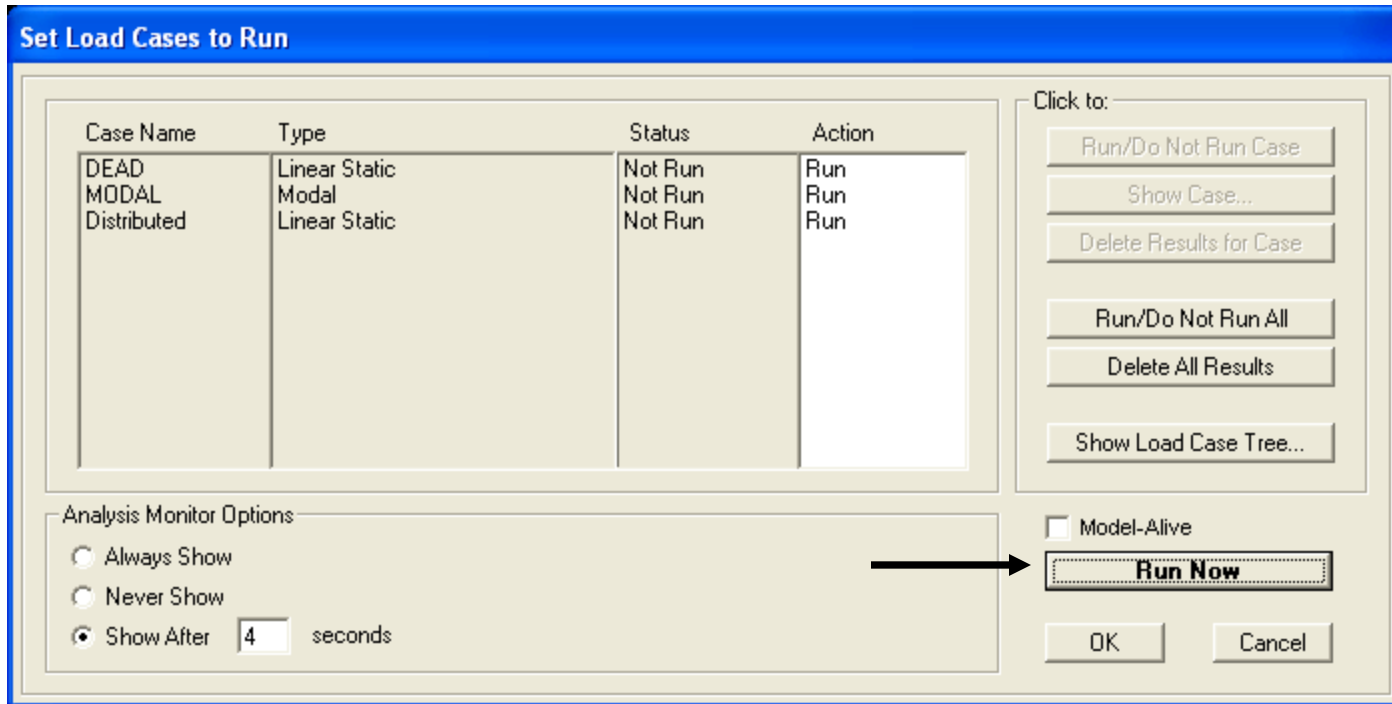

De-select extruded view and go to Options menu>Windows and switch to three windows. You can display different output and design results simultaneously in each window. The way you do this is to click inside a window to make it active, then use the buttons to select 'show deformed shape' or 'show forces/stresses' and select a load case or combo. Below you see joint deflections on the left, major moment diagram on upper right, and restraint/support reactions (in lbs) in the bottom right. If you right click the bottom chord in the Moment 3-3 diagram, you will see that SAP2000 treats that chord as a single physical member reporting it as 1 moment diagram rather than breaking it into 5 pieces at each brace intersection. This physical member functionality is also applied to design.

Deformed shapes 

Moment diagrams and joint reactions 

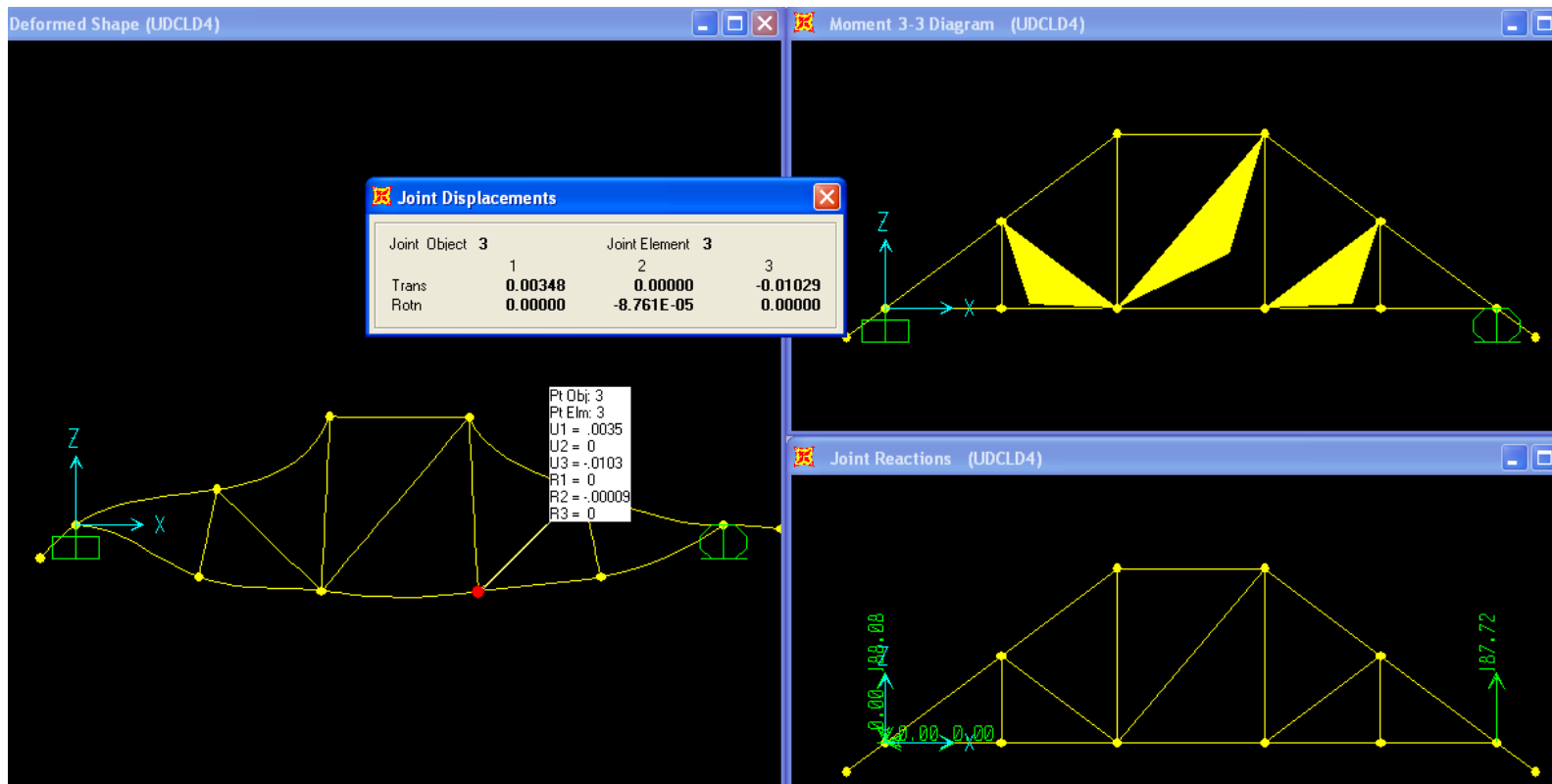

The next step is to run the AISI cold formed steel design check. Either add a button to do this on the top right, or use Design menu>Cold formed steel frame design>Start design/check of the structure. The design will automatically produce a color coded output. In this example, it appears that the top chord failed by a small margin whereas most of the other truss members have very low ratios, which indicate that a lighter sections for the other members may be more economical. The next step is to right click this chord to view more details.

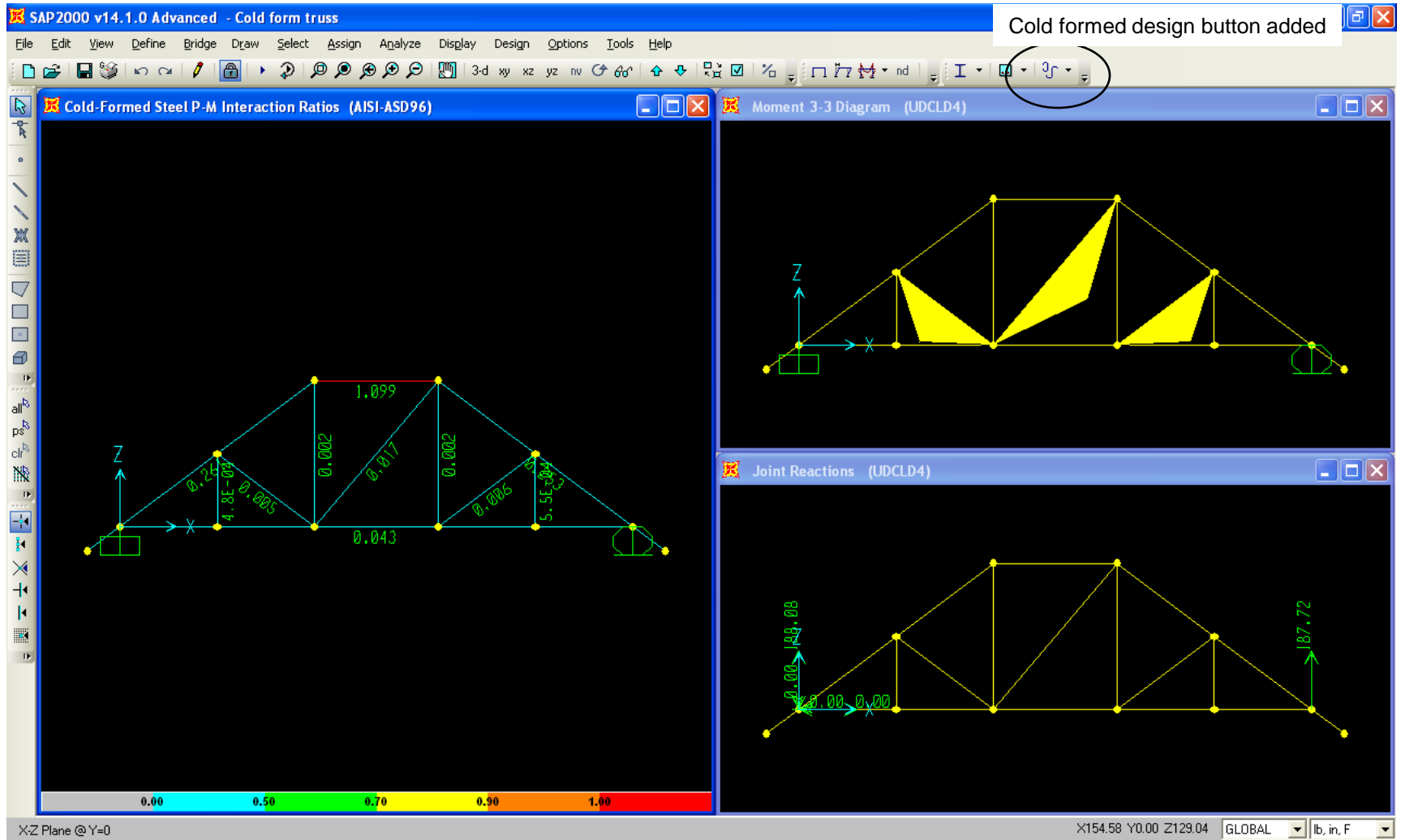

SAP2000 will automatically check every frame for every load combination at stations along the length of each frame and report the worst case load combination and location along the length of the frame. In this example, the worst case ratio exceeded the design allowable by less than 1%. Click Summary button to review design results for this chord member.

Cold-Formed Steel Stress Check Information (AISI-ASD96)

Frame ID: Analysis Section:
 Design Code: Design Section:

COMBO ID	STATION LOC	MOMENT RATIO	INTERACTION CHECK	MAJ-SHR RATIO	MIN-SHR RATIO
UDCLD2	45.50	0.194(C)	= 0.194 + 0.000 + 0.000	0.000	0.062
DCLD1	0.00	0.132(C)	= 0.132 + 0.000 + 0.000	0.000	0.002
DCLD1	22.75	0.155(C)	= 0.132 + 0.000 + 0.023	0.000	0.000
DCLD1	45.50	0.132(C)	= 0.132 + 0.000 + 0.000	0.000	0.002
DCLD2	0.00	0.194(C)	= 0.194 + 0.000 + 0.000	0.000	0.062
DCLD2	22.75	1.099(C)	= 0.194 + 0.000 + 0.906	0.000	0.000

Buttons: Modify/Show Overwrites (Overwrites), Display Details for Selected Item (Summary, Effective), Display Complete Details (Tabular Data), Stylesheet: Default, Table Format File, OK, Cancel

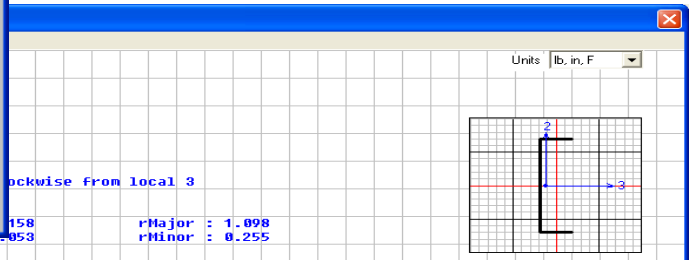

Major : 0.194 Minor : 0.000 Minor : 0.053
 IMinor : 0.000 E : 29500000.000 rMajor : 1.098
 Ixy : 0.000 Fy : 50000.000 rMinor : 0.255

DESIGN MESSAGES
 Error: Section overstressed

STRESS CHECK FORCES & MOMENTS						
Location	P	M33	M22	U2	U3	T
22.752	-237.540	0.000	667.247	0.000	0.000	0.000

PMH DEMAND/CAPACITY RATIO						
Governing Equation (CS-2.1-1)	Total Ratio	P Ratio	MMajor Ratio	MMinor Ratio	Ratio Limit	Status Check
(CS-2.1-1)	1.099	= 0.194	+ 0.000	+ 0.906	1.000	Overstress

AXIAL FORCE DESIGN						
	P Force	Pn Capacity	Pn0 Capacity	Tn Capacity	0megat Factor	0megac Factor
Axial	-237.540	2206.244	12220.359	13747.433	1.670	1.800

MOMENT DESIGN						
	M Moment	Mn Capacity	Mn(Yield) Capacity	Mn(LTB) Capacity	Mnt Capacity	
Major Moment	0.000	4692.695	11052.780	4692.695	11052.780	
Minor Moment	667.247	1482.331	1482.331	1482.331	4551.704	

Close the summary page and click the 'Overwrites' button for this frame member. SAP2000 makes a lot of intelligent design assumptions if the user accepts the defaults. However, in some cases these defaults are not adequate. In this case, the default was that the chord was not through fastened to the deck. If it was through fastened to the deck, you would want to take credit for that. Change from No to Yes and press OK.

Cold-Formed Steel Frame Design Overwrites for AISI-ASD96

Item	Value
1 Current Design Section	Program Determined
2 Framing Type	Program Determined
3 Live Load Reduction Factor	Program Determined
4 Unbraced Length Ratio (Major)	Program Determined
5 Unbraced Length Ratio (Minor, LTB)	Program Determined
6 Effective Length Factor (K Major)	Program Determined
7 Effective Length Factor (K Minor)	Program Determined
8 Moment Coefficient (Cm Major)	Program Determined
9 Moment Coefficient (Cm Minor)	Program Determined
10 Moment Coefficient (Ctf Major)	Program Determined
11 Moment Coefficient (Ctf Minor)	Program Determined
12 Bending Coefficient (Cb)	Program Determined
13 Moment Factor (Alpha Major)	Program Determined
14 Moment Factor (Alpha Minor)	Program Determined
15 Through Fastened To Deck?	No
16 Fastener Eccentricity, a/b	Program Determined
17 Hole Dia at Top Flange	Program Determined
18 Hole Dia at Bottom Flange	Program Determined
19 Hole Dia on Web	Program Determined
20 Yield Stress, Fy	Program Determined
21 Nominal Compressive Capacity, Pnc	Program Determined
22 Nominal Tensile Capacity, Pnt	Program Determined
23 Nominal Bending Capacity (Yield), Mn33	Program Determined
24 Nominal Bending Capacity (Yield), Mn22	Program Determined

Item Description

Explanation of Color Coding for Values

- Blue:** All selected items are program determined
- Black:** Some selected items are user defined
- Red:** Value that has changed during the current session

Set To Prog Determined (Default) Values

Reset To Previous Values

OK Cancel

That design parameter change lowered the design ratio to an acceptable 81% of allowable. To assign other design parameters, select frame members that you want to assign, and after you've selected them go Design>Cold formed steel frame design>View/revise overwrites to override program defaults.

Cold-Formed Steel Stress Check Information (AISI-ASD96)

Frame ID: Analysis Section:
 Design Code: Design Section:

COMBO ID	STATION LOC	----MOMENT INTERACTION CHECK----	--MAJ-SHR--	MIN-SHR-
ID	LOC	RATIO = AXL + B-MAJ + B-MIN	RATIO	RATIO
UDCLD2	45.50	0.059 (C) = 0.059 + 0.000 + 0.000	0.000	0.062
DCLD1	0.00	0.040 (C) = 0.040 + 0.000 + 0.000		
DCLD1	22.75	0.063 (C) = 0.040 + 0.000 + 0.023		
DCLD1	45.50	0.040 (C) = 0.040 + 0.000 + 0.000		
DCLD2	0.00	0.059 (C) = 0.059 + 0.000 + 0.000		
DCLD2	22.75	0.810 (C) = 0.059 + 0.000 + 0.752		

Modify/Show Overwrites: Display Details for Selected Item:

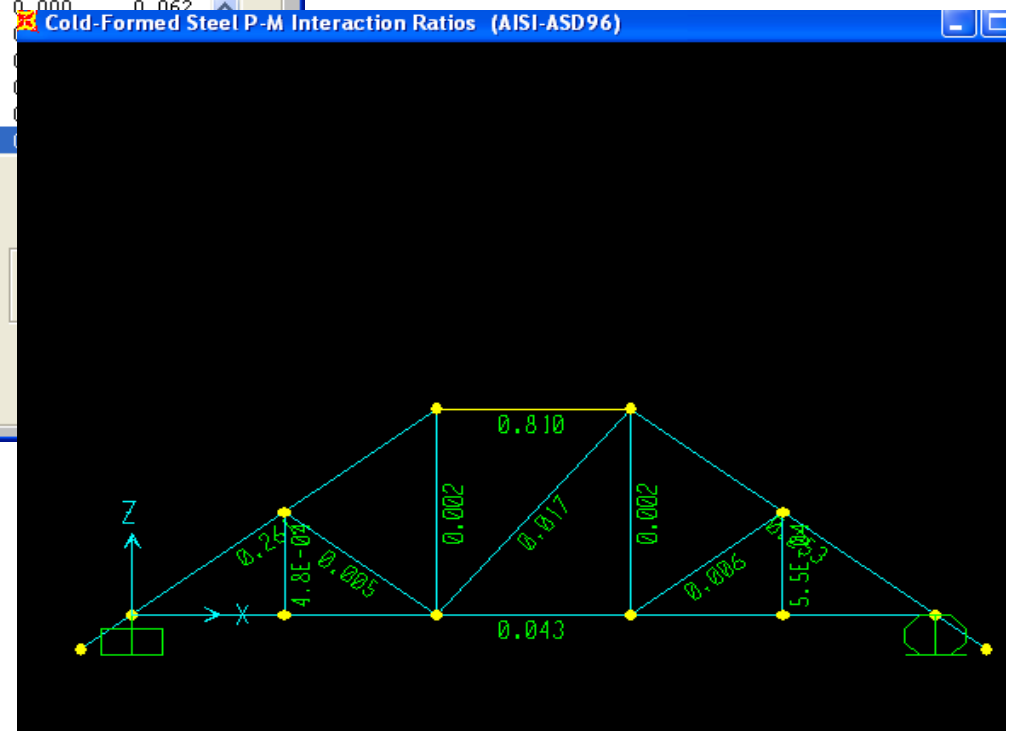

Display menu>Show tables will generate output reports which can be sorted and formatted, with options to automatically export to Excel and MS Access with bi-directional links with Tekla.

The image shows two windows side-by-side. On the left is a window titled "Joint Reactions" with a menu bar (File, View, Format-Filter-Sort, Select, Options) and a status bar (Units: As Noted). It contains a table with 10 rows of data. On the right is a Microsoft Excel window titled "Microsoft Excel - Book3" with a standard menu bar and toolbar. It shows the same data from the "Joint Reactions" window pasted into a spreadsheet starting at cell A4. An arrow points from the application window to the Excel window.

	Joint Text	OutputCase Text	CaseType Text	F3 Lb
▶	FIX SUPPORT	DEAD	LinStatic	131.17
	FIX SUPPORT	UDCLD1	Combination	131.17
	FIX SUPPORT	UDCLD2	Combination	188.08
	FIX SUPPORT	UDCLD3	Combination	131.17
	FIX SUPPORT	UDCLD4	Combination	188.08
	ROLLER SUPPORT	DEAD	LinStatic	130.88
	ROLLER SUPPORT	UDCLD1	Combination	130.88
	ROLLER SUPPORT	UDCLD2	Combination	187.72
	ROLLER SUPPORT	UDCLD3	Combination	130.88
	ROLLER SUPPORT	UDCLD4	Combination	187.72

Record: 1 of 10

	A	B	C	D	E	F
1	TABLE: Joint Reactions					
2	Joint	OutputCase	CaseType	F3		
3	Text	Text	Text	Lb		
4	FIX SUPPORT	DEAD	LinStatic	131.17		
5	FIX SUPPORT	UDCLD1	Combination	131.17		
6	FIX SUPPORT	UDCLD2	Combination	188.08		
7	FIX SUPPORT	UDCLD3	Combination	131.17		
8	FIX SUPPORT	UDCLD4	Combination	188.08		
9	ROLLER SUPPORT	DEAD	LinStatic	130.88		
10	ROLLER SUPPORT	UDCLD1	Combination	130.88		
11	ROLLER SUPPORT	UDCLD2	Combination	187.72		
12	ROLLER SUPPORT	UDCLD3	Combination	130.88		
13	ROLLER SUPPORT	UDCLD4	Combination	187.72		
14						
15						
16						
17						
18						
19						
20						
21						

The main portion of this tutorial is completed, but there is 1 minor issue to be aware of. If you look closely at the G26_15 dimensions, it appears the dimensions to the two tallest vertical braces were not to the centerline of the braces, but dimensioned to their outer edges. In our model, we connected members using centerlines. In many cases, this centerline modeling approach is adequate, and consideration of cardinal work points may be considered 'splitting hairs'. However it can affect reactions, and if a user wants to consider these cardinal work point locations in SAP2000, it's easy enough to do. Click anywhere in your XZ planar view window then use 'set display options' to activate extruded view in your XZ planar view as shown. Click the padlock button  to unlock your model, change units to lb, in, F, then click to select the tall vertical brace on the left side as shown, then Assign>Frame>Insertion point. Change Coord system to 'Global' and type 1.2 inches in X direction End-I and End-J using $\frac{1}{2}$ the dimension of the HAT-1 section and press OK. In orthogonal modeling of beams and columns, use of the Cardinal point would be all that would be needed, but since the chord is sloped, we need to specify the offset in this manner. Use of the Cardinal point feature 'moves' the frame, but retains connectivity while automatically adding internal rigid links from the centerline of the previous location to it's new location in order to accurately account for changes in reactions.

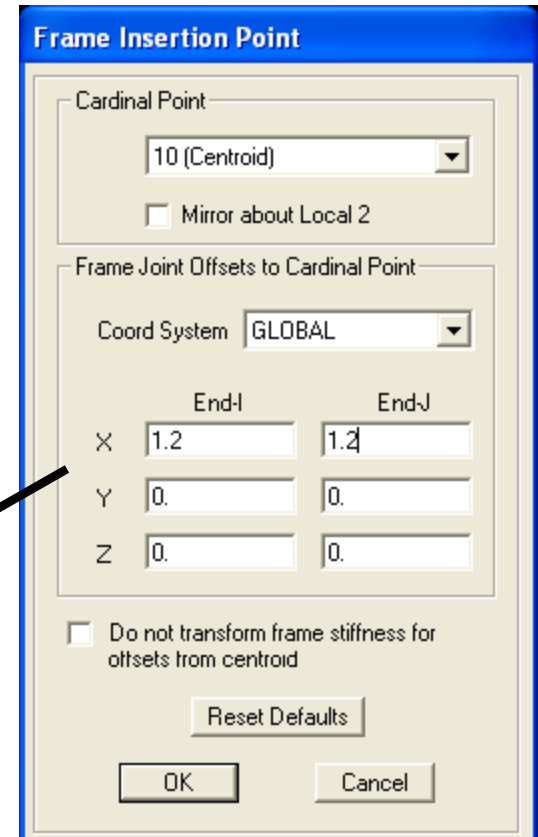
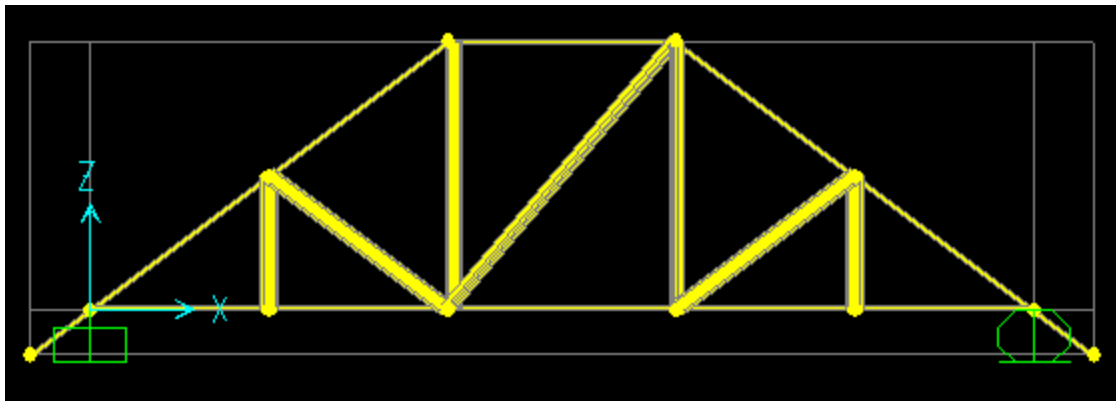
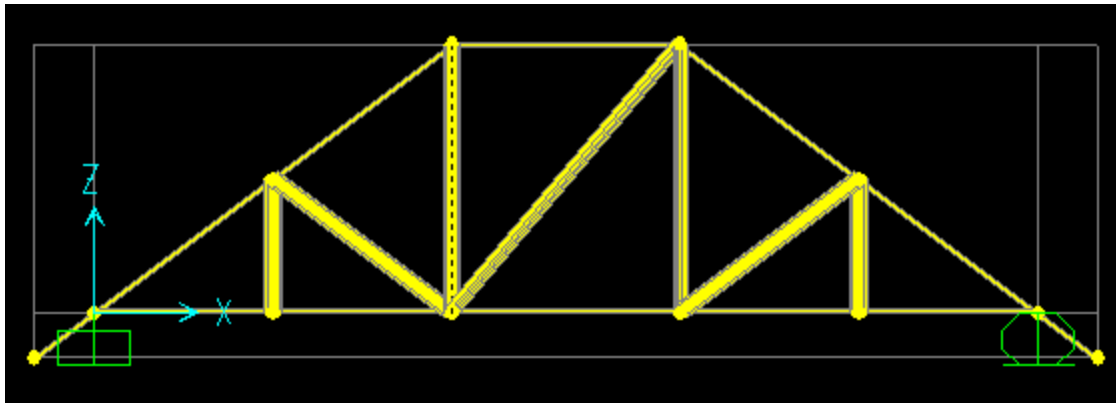

Now select the tall vertical brace on the right side and assign a frame insertion point, but this time -1.2" in the X direction in both I and J ends of the frame. While the frame insertion point dialogue is open, you can press F1 for Help to read more about this feature.

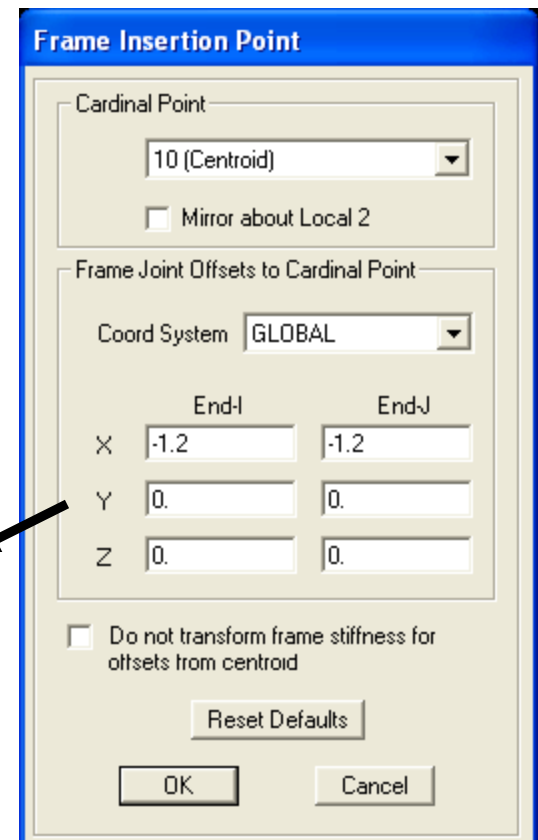
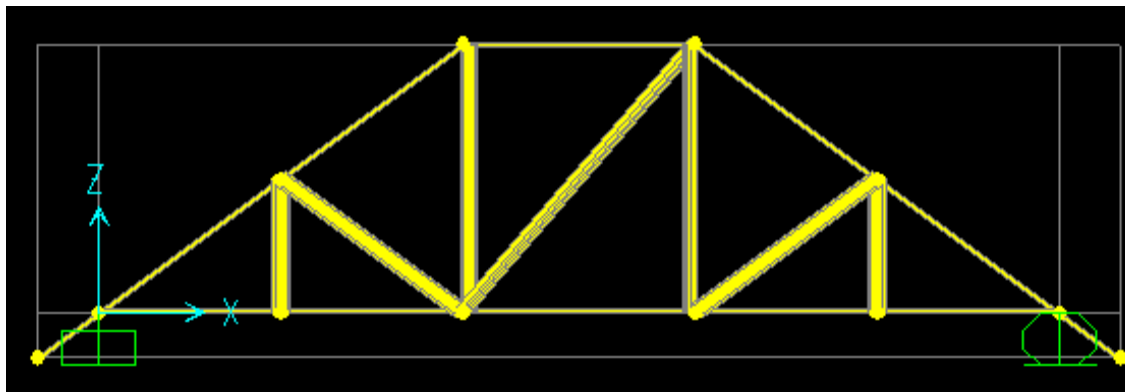
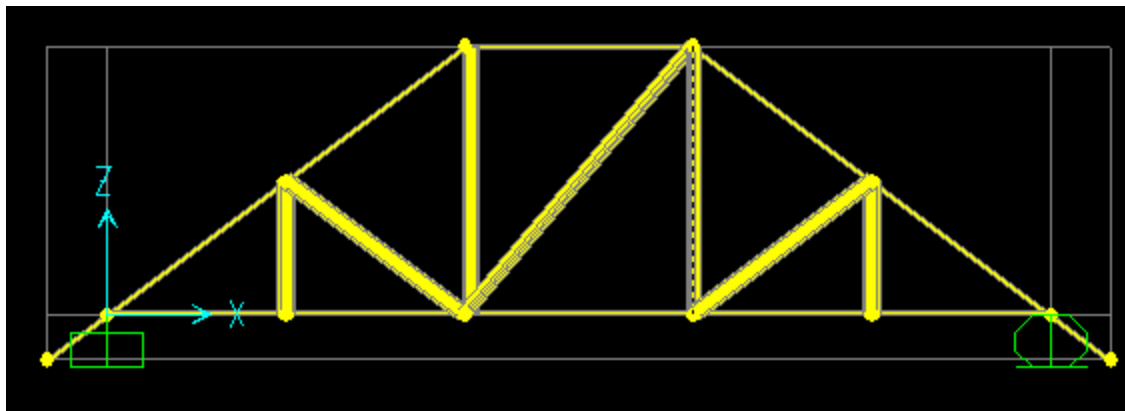

Next, right click the sloped chord on the left to display info, and from the location tab we see that this chord is 104.06" long. We're going quickly cover an alternative modeling method for drawing sloped frames which may be useful in certain situations. Press Ok to close the line information form, then left click to select the left side sloped chord and press Del key on your keyboard to delete it.

Object Model - Line Information

Location | Assignments | Loads | Design

Identification

Label: Design Procedure:

Length	104.0606
Line Object Type	Straight Frame
Start Joint (I)	9
Coordinate System	GLOBAL
X	-12.
Y	0.
Z	-9.
End Joint (J)	5
Coordinate System	GLOBAL
X	71.2488
Y	0.
Z	53.436

lb, in, F

Reset All

Update Display

Modify Display

OK

Cancel

Double click white background cell to edit item.

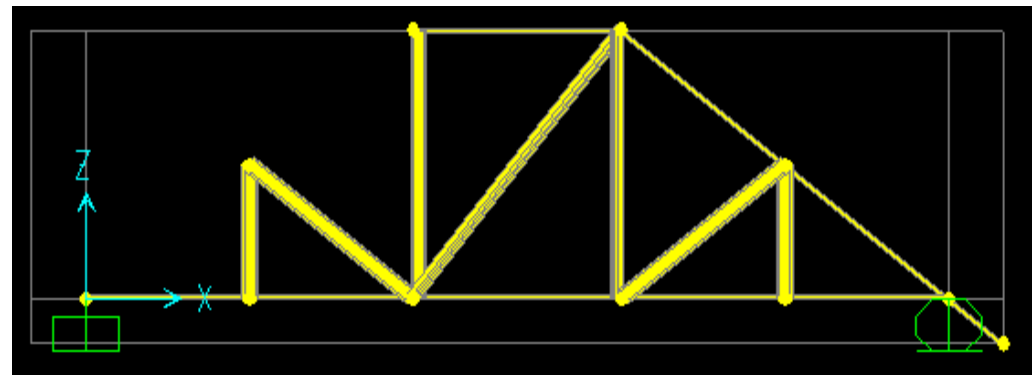

We know that the chord is 104.0606" long with a pitch of 9/12. A pitch of 9/12 = angle 36.87 degrees. Click draw frame/cable button, change Section to C-1 and Moment release Continuous and click the top of the left side vertical brace, then type S on your keyboard and enter Fixed length of -104.0606 (inches) and Fixed Angle of 36.87 as shown and double click to complete the drawing of that chord frame. This is an alternative method of modeling sloped beams, columns and bracing.

